



084R8041



R18PT102



Identification

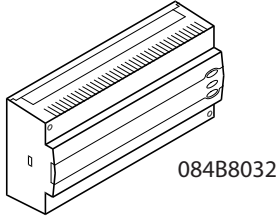

Dimensions

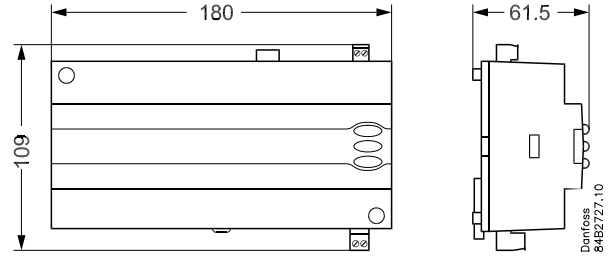

Principle

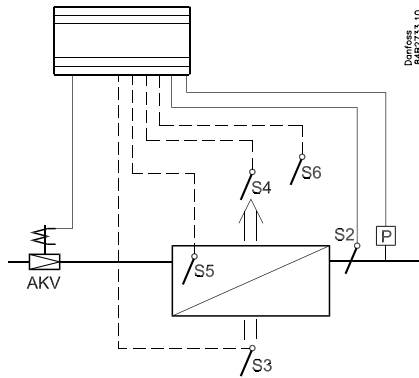

S2:
Insulate sensor
Fühler isolieren
Capteur isolés
Isolér føleren
Sensores aislados

AKV info !!

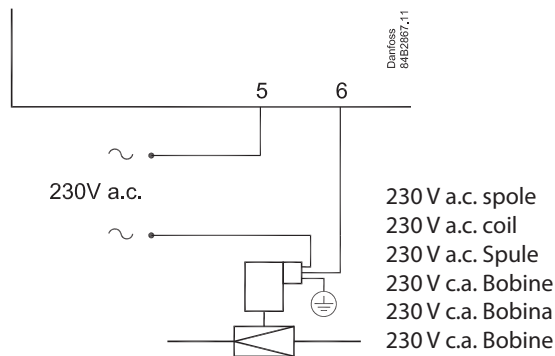

AK-CC 550B

Additional information:	English Manual	RS8GL...	www.danfoss.com
Weitere Information:	Deutsches Manual		
Renseignements supplémentaires:	Manuel en français		
Yderligere information:	Dansk Manual		
Información adicional:	Manual español		
Informazioni aggiuntive!	Manuale in italiano		
Ytterligare information:	Svenska Handbok		
Aanvullende informatie:	Dutch Handleiding		

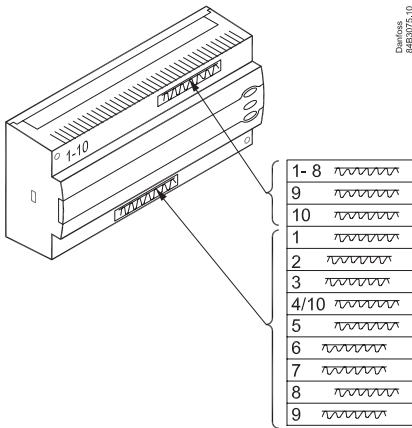

Danfoss
84B3075.10

The controller is provided with signs from the factory indicating application 1. If you employ another use, signs are provided so that you can mount the relevant one.

Werkseitig wird der Regler mit Schildern geliefert, die Anwendung 1 angeben. Wenn Sie eine andere Anwendung verwenden, so montieren Sie bitte das entsprechende der mitgelieferten Schilder.

Les régulateurs sortis d'usine sont livrés avec une étiquette indiquant l'utilisation 1. Si vous optez pour une autre utilisation, des plaques sont jointes pour vous permettre de monter la plaque adéquate.

Fra fabrikken er regulatoren leveret med skilte, der angiver anvendelse 1. Hvis du benytter en anden anvendelse, er der medleveret skilte, så du kan montere det aktuelle.

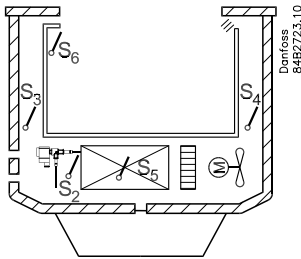

Danfoss
84B2723.10

1 - 8

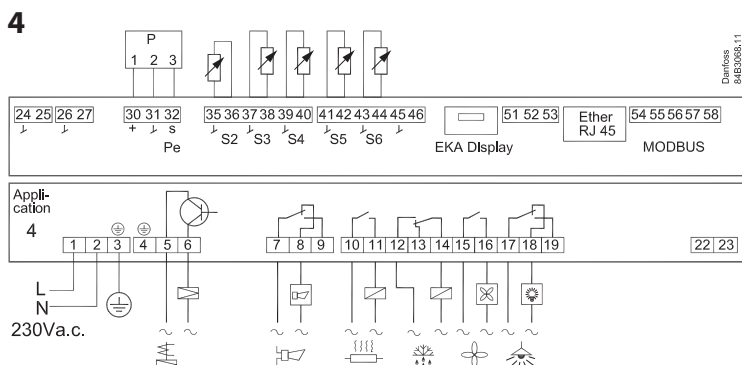
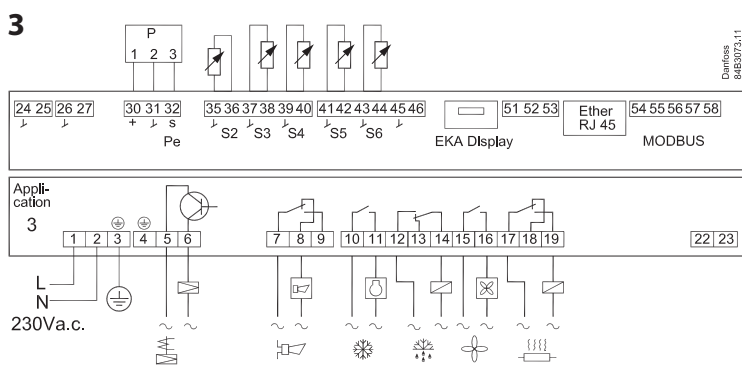
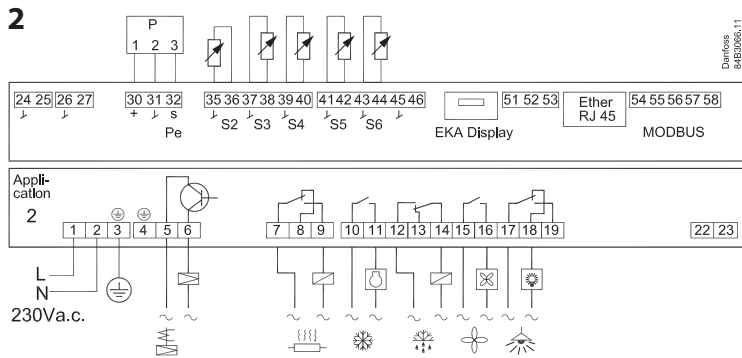
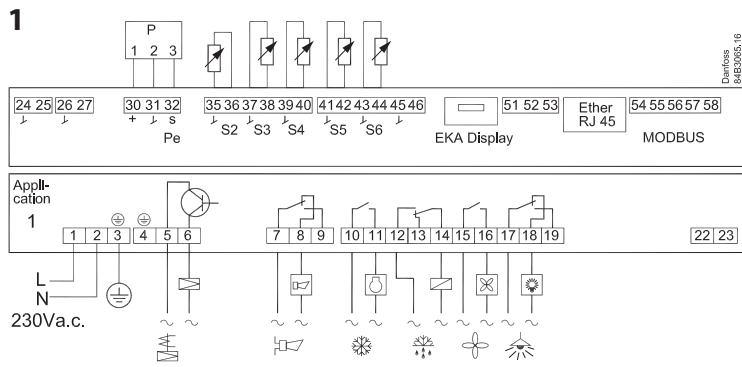

5

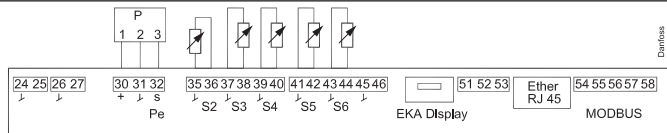

Danfoss
84B3065.1.1

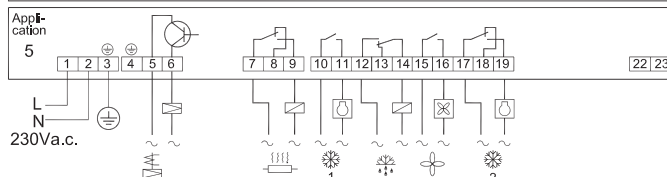

6

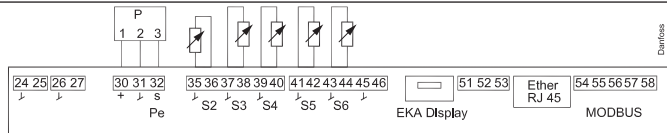

Danfoss
84B3067.1.1

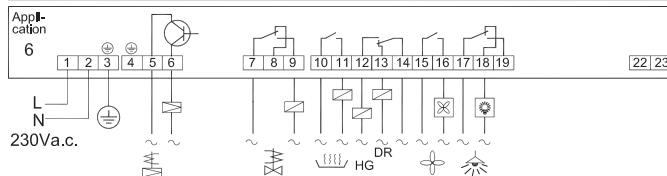

7

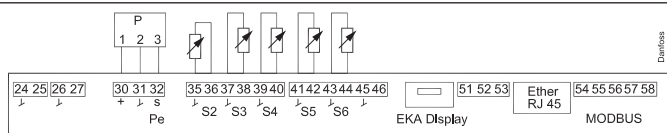

Danfoss
84B3070.1.1

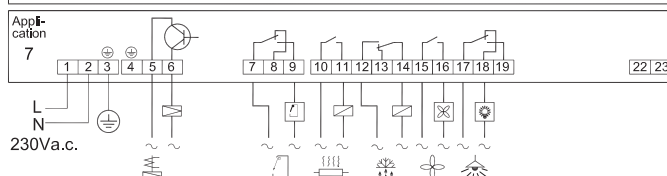

8

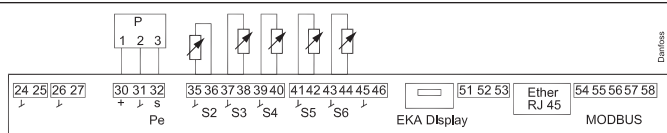

Danfoss
84B3071.1.1

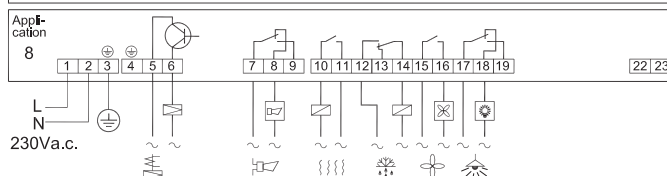

9

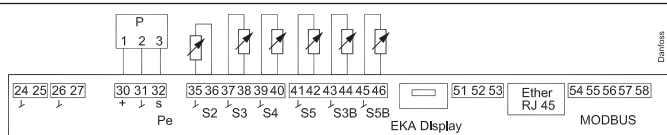

Danfoss
84B3054.1.0

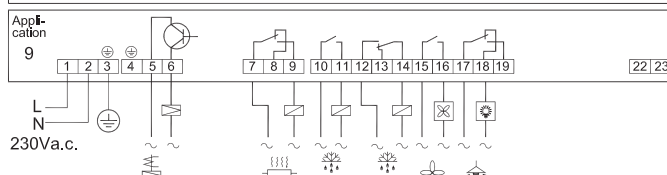

10

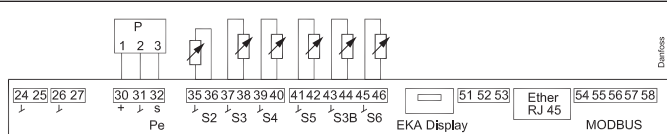

Danfoss
84B3074.1.0

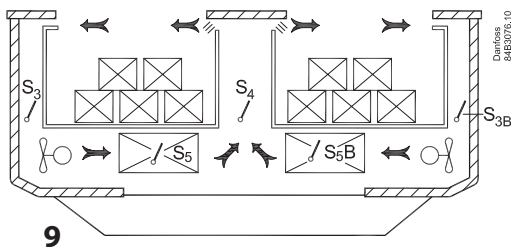
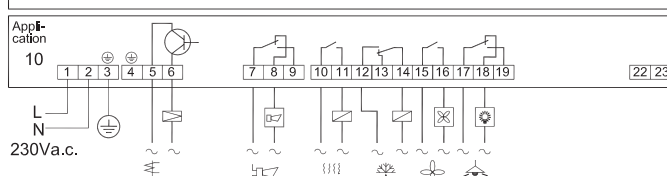

Danfoss
84B3076.1.0

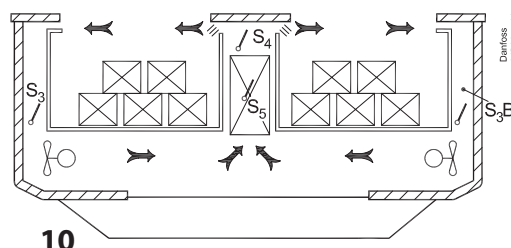

Danfoss
84B3077.1.0

Data communication
Datenkommunikation
Transmission de données
Datakommunikation

- Important** All connections to the data communication MODBUS, DANBUSS and RS 485 must comply with the requirements for data communication cables. See literature: RC8AC.
- Wichtig** Alle Anschlüsse an die Datenkommunikation MODBUS, DANBUSS und RS 485 müssen die Anforderungen erfüllen, die an Datenkommunikationskabel gestellt werden. Siehe Literatur: RC8AC
- Important** Tout raccordement au système de données MODBUS, DANBUSS et à RS 485 doit satisfaire à la norme applicable pour les câbles de transmission de données. Voir documentation : RC8AC
- Viktigt** Alle tilslutninger til datakommunikationen MODBUS, DANBUSS og RS 485, skal overholde de krav, der stilles til datakommunikationskabler. Se litteratur: RC8AC

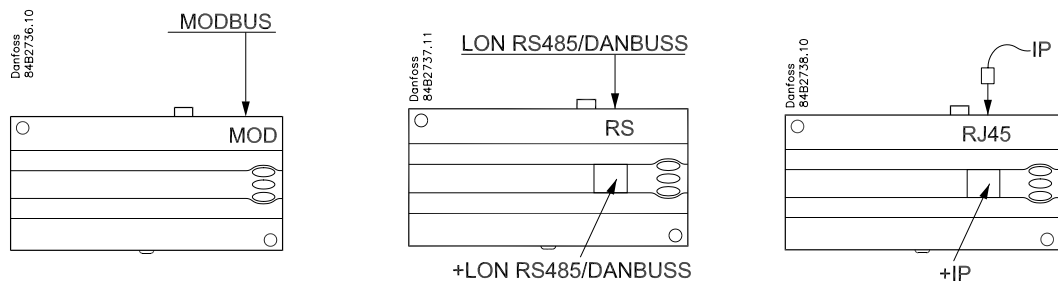

System manager / Gateway

AK-SM....

AKA 245 version 6.20+ / AK-SM...

OEM

Display EKA 163 / 164

L < 15 m

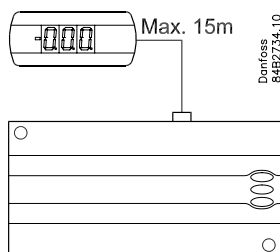

L > 15 m

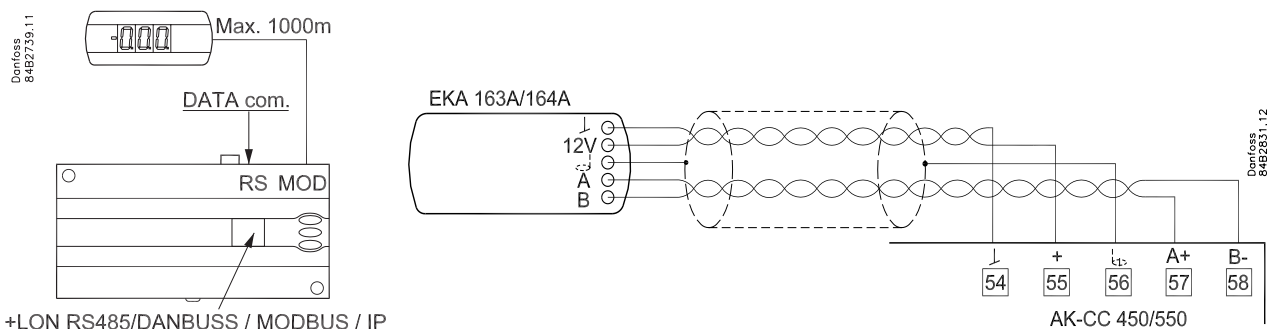

Connections

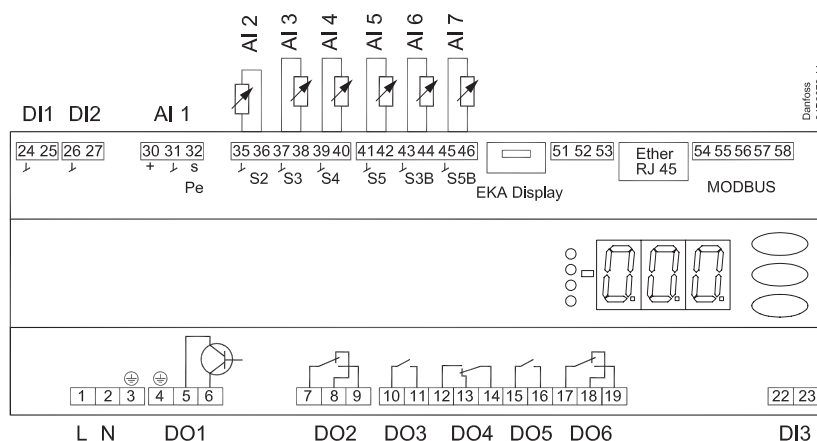

Danfoss
84B076.11

Overview of outputs and applications.

See also electrical diagrams earlier in the instruction

Application	DO1	DO2	DO3	DO4	DO5	DO6	DI1	DI2	DI3	AI1	AI2	AI3	AI4	AI5	AI6	AI7
1							●	●	●	P0	S2	S3	S4	S5	S6	
2							●	●	●	P0	S2	S3	S4	S5	S6	
3							●	●	●	P0	S2	S3	S4	S5	S6	
4							●	●	●	P0	S2	S3	S4	S5	S6	
5							●	●	●	P0	S2	S3	S4	S5	S6	
6							●	●	●	P0	S2	S3	S4	S5	S6	
7							●	●	●	P0	S2	S3	S4	S5	S6	
8							●	●	●	P0	S2	S3	S4	S5	S6	
9							●	●	●	P0	S2	S3	S4	S5	S3B	S5B
10							●	●	●	P0	S2	S3	S4	S5	S3B	S6

DI1

Digital input signal.
The defined function is active when the input is short-circuited/
opened. The function is defined in o02.

DI2

Digital input signal.
The defined function is active when the input is short-circuited/
opened. The function is defined in o37.

Pressure transmitter

AKS 32R

Connect to terminal 30, 31 and 32.
(Used cable 060G1034: Black=30, Blue=31, Brown=32)
The signal from one pressure transmitter can be received by up
to 10 controllers. But only if there are no significant pressure
decreases between the evaporators to be controlled. See
drawing page 36.

S2

Pt 1000 ohm sensor

S3, S4, S5, S6

Pt 1000 ohm sensor or PTC 1000 ohm sensor. All have to be of
the same type.

S3, air sensor, placed in the warm air before the evaporator

S4, air sensor, placed in the cold air after the evaporator
(the need for either S3 or S4 can be deselected in the
configuration)

S5, defrost sensor, placed on the evaporator

S6, product sensor

EKA Display

If there is be external reading/operation of the controller, display
type EKA 163B or EKA 164B can be connected.

RS485 (terminal 51, 52, 53)

For data communication, but only if a data communication
module is inserted in the controller. The module can be a LON
RS485, DANBUSS or a MODBUS.

Terminal 51 = screen

Terminal 52 = A (A+)

Terminal 53 = B (B-)

(For LON RS485 and gateway type AKA 245 the gateway must be
version 6.20 or higher.)

RJ45

For data communication, but only if a TCP/IP module is inserted in
the controller. (OEM)

MODBUS

For data communication.

Terminal 56 = screen

Terminal 57 = A+

Terminal 58 = B-

(Alternatively the terminals can be connected to an external
display type EKA 163A or 164A, but then they cannot be used
for data communication. Any data communication must then be
carried out by one of the other methods.)

Supply voltage

230 V a.c., 50/60 Hz

DO1

Connection of expansion valve type AKV or AKVA. The coil must
be a 230 V a.c. coil.

DO2

Alarm

There is a connection between terminal 7 and 8 in alarm situations and when the controller is without power.

Rail heat and heating element in drip tray

There is connection between terminal 7 and 9 when heating takes place.

Night blind

There is connection between terminal 7 and 9 when the night blind is up.

Suction line valve

There is connection between terminal 7 and 9 when the suction line must be open.

DO3

Refrigeration, Rail heat, Heat function, Defrost 2

There is connection between terminal 10 and 11 when the function must be active.

Heating element in drip tray

There is connection between terminal 10 and 11 when heating takes place.

DO4

Defrost

There is connection between terminal 12 and 14 when defrosting takes place.

Hot gas / drain valve

There is connection between terminal 13 and 14 during normal operation.

There is connection between terminal 12 and 14 when the hot gas valves must open.

DO5

Fan

There is connection between terminal 15 and 16 when the fan is on.

DO6

Light relay

There is connection between terminal 17 and 18 when the light must be on.

Rail heat, Compressor 2

There is connection between terminal 17 and 19 when the function must be active.

DI3

Digital input signal.

The signal must have a voltage of 0 / 230 V AC.

The function is defined in o84.

Data communication

If data communication is used, it is important that the installation of the data communication cable is performed correctly. See separate literature No. RC8AC...

Electric noise

Cables for sensors, DI inputs and data communication **must** be kept separate from other electric cables:

- Use separate cable trays
- Keep a distance between cables of at least 10 cm
- Long cables at the DI input should be avoided

Installation considerations

Accidental damage, poor installation, or site conditions, can give rise to malfunctions of the control system, and ultimately lead to a plant breakdown.

Every possible safeguard is incorporated into our products to prevent this. However, a wrong installation, for example, could still present problems. Electronic controls are no substitute for normal, good engineering practice.

Danfoss will not be responsible for any goods, or plant components, damaged as a result of the above defects. It is the installer's responsibility to check the installation thoroughly, and to fit the necessary safety devices.

Special reference is made to the necessity of signals to the controller when the compressor is stopped and to the need of liquid receivers before the compressors.

Your local Danfoss agent will be pleased to assist with further advice, etc.

Coordinated defrost via cable connections

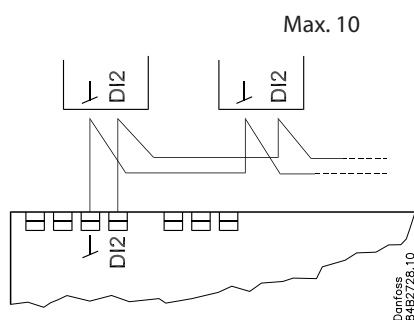

The following controllers can be connected up in this way:

EKC 204A, AK-CC 210, AK-CC 250, AK-CC 450, AK-CC 550A,

Refrigeration is resumed when all controllers have "released" the signal for defrost.

Coordinated defrost via data communication

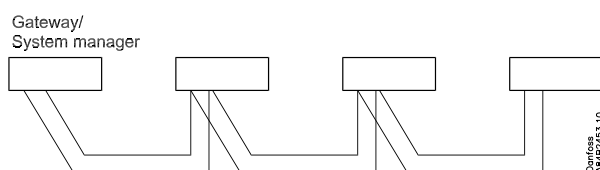

The setting of controllers to coordinate their defrosting takes place in the gateway/system manager.

Refrigeration is resumed when all controllers have "released" the signal for defrost.

Operation

Display

The values will be shown with three digits, and with a setting you can determine whether the temperature is to be shown in °C or in °F.

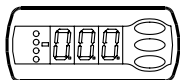

Light-emitting diodes (LED) on front panel

The LED's on the front panel will light up when the relevant relay is activated.

- = Refrigeration
- = Defrost
- = Fan running

The light-emitting diodes will flash when there is an alarm. In this situation you can download the error code to the display and cancel/sign for the alarm by giving the top button a brief push.

The buttons

When you want to change a setting, the upper and the lower buttons will give you a higher or lower value depending on the button you are pushing. But before you change the value, you must have access to the menu. You obtain this by pushing the upper button for a couple of seconds - you will then enter the column with parameter codes. Find the parameter code you want to change and push the middle buttons until value for the parameter is shown. When you have changed the value, save the new value by once more pushing the middle button.

Examples

Set menu

1. Push the upper button until a parameter r01 is shown
2. Push the upper or the lower button and find that parameter you want to change
3. Push the middle button until the parameter value is shown
4. Push the upper or the lower button and select the new value
5. Push the middle button again to freeze the value.

Cutout alarm relay / receipt alarm/see alarm code

- A short press of the upper button
 - If there are several alarm codes they are found in a rolling stack. Push the uppermost or lowermost button to scan the rolling stack.

Set temperature

1. Push the middle button until the temperature value is shown
2. Push the upper or the lower button and select the new value
3. Push the middle button again to conclude the setting.

Reading the temperature at defrost sensor (Or product sensor, if selected in o92.)

- A short press of the lower button

Manuel start or stop of a defrost

- Push the lower button for four seconds.

Get a good start

With the following procedure you can start regulation very quickly:

- 1 Open parameter r12 and stop the regulation (in a new and not previously set unit, r12 will already be set to 0 which means stopped regulation.)
- 2 Select electrical connection based on the drawings on page 2 and 3
- 3 Open parameter o61 and set the electric connection number in it
- 4 Now select one of the preset settings from the table

Auxiliary schedule for settings (quick-setup)	Case			Room		
	Defrost stop on			Defrost stop on		
	time	S5		time	S5	
Preset settings (o62)	1	2	3	4	5	6
Temperature (SP)	2°C	-2°C	-28°C	4°C	0°C	-22°C
Max. temp. setting (r02)	6°C	4°C	-22°C	8°C	5°C	-20°C
Min. temp. setting (r03)	0°C	-4°C	-30°C	0°C	-2°C	-24°C
Sensor signal for thermostat. S4% (r15)	100%			0%		
Alarm limit high (A13)	8°C	6°C	-15°C	10°C	8°C	-15°C
Alarm limit low (A14)	-5°C	-5°C	-30°C	0°C	0°C	-30°C
Sensor signal for alarm funct.S4% (A36)	0%		100%	0%		
Interval between defrost (d03)	6 h	6h	12h	8h	8h	6h
Defrost sensor: 0=time, 1=S5, 2=S4 (d10)	0	1	1	0	1	1
D11 config. (o02)	Case cleaning (=10)			Door function (=2)		
Sensor signal for display view S4% (017)	0%					

- 5 Open parameter o62 and set the number for the array of presettings. The few selected settings will now be transferred to the menu.
- 6 Select refrigerant via parameter o30
- 7 Open parameter r12 and start the regulation
- 8 Go through the survey of factory settings. The values in the grey cells are changed according to your choice of settings. Make any necessary changes in the respective parameters.
- 9 For network. Set the address in o03
- 10 Send address to system unit:
 - MODBUS: Activate scan function in system unit
 - If another data communication card is used in the controller:
 - LON RS485: Activate the function o04
 - DANBUSS: Activate the function o04
 - Ethernet: Use the MAC Address

Menu survey

SW = 1.6x

Function	Parameter	Code	EL-diagram page 2 and 3										Min.-value	Max.-value	Factory setting	Actual setting		
			1	2	3	4	5	6	7	8	9	10						
Normal operation																		
Temperature (setpoint)		---	1	1	1	1	1	1	1	1	1	1	1	1	1	-50°C	50°C	2
Thermostat																		
Differential	r01		1	1	1	1	1	1	1	1	1	1	1	1	1	0.1 K	20 K	2
Max. limitation of setpoint setting	r02		1	1	1	1	1	1	1	1	1	1	1	1	1	-49°C	50°C	50
Min. limitation of setpoint setting	r03		1	1	1	1	1	1	1	1	1	1	1	1	1	-50°C	49°C	-50
Adjustment of temperature indication	r04		1	1	1	1	1	1	1	1	1	1	1	1	1	-10	10	0
Temperature unit (°C/°F)	r05		1	1	1	1	1	1	1	1	1	1	1	1	1	0/°C	1/F	0/°C
Correction of the signal from S4	r09		1	1	1	1	1	1	1	1	1	1	1	1	1	-10 K	10 K	0
Correction of the signal from S3 and S3B	r10		1	1	1	1	1	1	1	1	1	1	1	1	1	-10 K	10 K	0
Manual service, stop regulation, start regulation (-1, 0, 1)	r12		1	1	1	1	1	1	1	1	1	1	1	1	1	-1	1	0
Displacement of reference during night operation	r13		1	1	1	1	1	1	1	1	1	1	1	1	1	-50 K	50 K	0
Define thermostat function 1=ON/OFF, 2=Modulating	r14		1	1	1	1	1	1	1	1	1	1	1	1	1	1	2	1
Definition and weighting, if applicable, of thermostat sensors - S4% (100%=S4, 0%=S3)	r15		1	1	1	1	1	1	1	1	1	1	1	1	1	0 %	100 %	100
Time between melt periods	r16		1	1	1	1	1	1	1	1	1	1	1	1	1	0 hrs	10 hrs	1
Duration of melt periods	r17		1	1	1	1	1	1	1	1	1	1	1	1	1	0 min.	30 min.	5
Temperature setting for thermostat band 2 . As differential use r01	r21		1	1	1	1	1	1	1	1	1	1	1	1	1	-50°C	50°C	2
Correction of the signal from S6	r59		1	1	1	1	1	1	1	1	1	1	1	1	1	-10 K	10 K	0
Definition and weighting, if applicable, of thermostat sensors when night cover is on. (100%=S4, 0%=S3)	r61													1		0 %	100 %	100
Heat function Neutral zone between refrigeration and heat function	r62														1	0 K	50 K	2
Time delay at switch between refrigeration and heat function	r63														1	0 min.	240 min.	0
Alarms																		
Delay for temperature alarm	A03		1	1	1	1	1	1	1	1	1	1	1	1	1	0 min.	240 min.	30
Delay for door alarm	A04		1	1	1	1	1	1	1	1	1	1	1	1	1	0 min.	240 min.	60
Delay for temperature alarm after defrost	A12		1	1	1	1	1	1	1	1	1	1	1	1	1	0 min.	240 min.	90
High alarm limit for thermostat 1	A13		1	1	1	1	1	1	1	1	1	1	1	1	1	-50°C	50°C	8
Low alarm limit for thermostat 1	A14		1	1	1	1	1	1	1	1	1	1	1	1	1	-50°C	50°C	-30
High alarm limit for thermostat 2	A20		1	1	1	1	1	1	1	1	1	1	1	1	1	-50°C	50°C	8
Low alarm limit for thermostat 2	A21		1	1	1	1	1	1	1	1	1	1	1	1	1	-50°C	50°C	-30
High alarm limit for sensor S6 at thermostat 1	A22		1	1	1	1	1	1	1	1	1	1	1	1	1	-50°C	50°C	8
Low alarm limit for sensor S6 at thermostat 1	A23		1	1	1	1	1	1	1	1	1	1	1	1	1	-50°C	50°C	-30
High alarm limit for sensor S6 at thermostat 2	A24		1	1	1	1	1	1	1	1	1	1	1	1	1	-50°C	50°C	8
Low alarm limit for sensor S6 at thermostat 2	A25		1	1	1	1	1	1	1	1	1	1	1	1	1	-50°C	50°C	-30
S6 alarm time delay With setting = 240 the S6 alarm will be omitted	A26		1	1	1	1	1	1	1	1	1	1	1	1	1	0 min.	240 min.	240
Alarm time delay or signal on the DI1 input	A27		1	1	1	1	1	1	1	1	1	1	1	1	1	0 min.	240 min.	30
Alarm time delay or signal on the DI2 input	A28		1	1	1	1	1	1	1	1	1	1	1	1	1	0 min.	240 min.	30
Signal for alarm thermostat. S4% (100%=S4, 0%=S3)	A36		1	1	1	1	1	1	1	1	1	1	1	1	1	0 %	100 %	100
Delay for S6 (product sensor alarm) after defrost	A52		1	1	1	1	1	1	1	1	1	1	1	1	1	0 min.	240 min.	90
Delay for temperature alarm S3B	A53														1	0 min.	240 min.	90
Compressor																		
Min. ON-time	c01		1	1	1		1									0 min.	30 min.	0
Min. OFF-time	c02		1	1	1		1									0 min.	30 min.	0
Time delay for cutin of comp.2	c05						1									0 sec	999 sec	5
Defrost																		
Defrost method: 0=none, 1= EL, 2= Gas	d01		1	1	1	1	1	1	1	1	1	1	1	1	1	0/No	2/GAs	1/EL
Defrost stop temperature	d02		1	1	1	1	1	1	1	1	1	1	1	1	1	0°C	50°C	6
Interval between defrost starts	d03		1	1	1	1	1	1	1	1	1	1	1	1	1	0 hrs/Off	240 hrs	8
Max. defrost duration	d04		1	1	1	1	1	1	1	1	1	1	1	1	1	0 min.	360 min.	45
Displacement of time on cutin of defrost at start-up	d05		1	1	1	1	1	1	1	1	1	1	1	1	1	0 min.	240 min.	0
Drip off time	d06		1	1	1	1	1	1	1	1	1	1	1	1	1	0 min.	60 min.	0
Delay for fan start after defrost	d07		1	1	1	1	1	1	1	1	1	1	1	1	1	0 min.	60 min.	0
Fan start temperature	d08		1	1	1	1	1	1	1	1	1	1	1	1	1	-50 °C	0 °C	-5

Continued	Code	1	2	3	4	5	6	7	8	9	10	Min.	Max.	Fac.	Actual
Fan cutin during defrost 0: Stopped 1: Running 2: Running during pump down and defrost	d09	1	1	1	1	1	1	1	1	1	1	0	2	1	
Defrost sensor: 0=Stop on time, 1=S5, 2=S4, 3=Sx (Application 1-8 and 10: both S5 and S6. Application 9: S5 and S5B)	d10	1	1	1	1	1	1	1	1	1	1	0	3	0	
Pump down delay	d16	1	1	1	1	1	1	1	1	1	1	0 min.	60 min.	0	
Drain delay (used at hot gas defrost only)	d17						1					0 min.	60 min.	0	
Max. aggregate refrigeration time between two defrosts	d18	1	1	1	1	1	1	1	1	1	1	0 hrs	48 hrs	0/OFF	
Heat in drip tray. Time from defrosting stops to heating in the drip tray is switched off	d20						1					0 min.	240 min.	30	
Adaptive defrost: 0=not active, 1=monitoring only, 2=skip allowed day, 3=skip allowed both day and night, 4=own assessment + all schedules	d21	1	1	1	1	1	1	1	1	1	1	0	4	0	
Injection control function															
Max. value of superheat reference	n09	1	1	1	1	1	1	1	1	1	1	2°C	20°C	12	
Min. value of superheat reference	n10	1	1	1	1	1	1	1	1	1	1	2°C	20°C	3	
MOP temperature. Off if MOP temp. = 15.0 °C	n11	1	1	1	1	1	1	1	1	1	1	-50°C	15°C	15	
Period time of AKV pulsation Only for trained personnel	n13	1	1	1	1	1	1	1	1	1	1	3 sec	6 sec	6	
Fan															
Fan stop temperature (S5)	F04	1	1	1	1	1	1	1	1	1	1	-50°C	50°C	50	
Pulse operation on fans: 0=No pulse operation, 1=At thermostat cuts out only, 2= Only at thermostat cut outs during night operation	F05	1	1	1	1	1	1	1	1	1	1	0	2	0	
Period time for fan pulsation (on-time + off-time)	F06	1	1	1	1	1	1	1	1	1	1	1 min.	30 min.	5	
On-time in % of period time	F07	1	1	1	1	1	1	1	1	1	1	0 %	100 %	100	
Real time clock															
Six start times for defrost. Setting of hours. 0=OFF	t01 - t06	1	1	1	1	1	1	1	1	1	1	0 hrs	23 hrs	0	
Six start times for defrost. Setting of minutes. 0=OFF	t11 - t16	1	1	1	1	1	1	1	1	1	1	0 min.	59 min.	0	
Clock - Setting of hours	t07	1	1	1	1	1	1	1	1	1	1	0 hrs	23 hrs	0	
Clock - Setting of minute	t08	1	1	1	1	1	1	1	1	1	1	0 min.	59 min.	0	
Clock - Setting of date	t45	1	1	1	1	1	1	1	1	1	1	1 day	31 day	1	
Clock - Setting of month	t46	1	1	1	1	1	1	1	1	1	1	1 mon.	12 mon.	1	
Clock - Setting of year	t47	1	1	1	1	1	1	1	1	1	1	0 year	99 year	0	
Miscellaneous															
Delay of output signals after start-up	o01	1	1	1	1	1	1	1	1	1	1	0 sec	600 sec	5	
Input signal on DI1. Function: 0=not used. 1=status on DI1. 2=door function with alarm when open. 3=door alarm when open. 4=defrost start (pulse-signal). 5=ext.main switch. 6=night operation 7=thermostat band changeover (activate r21). 8=alarm function when closed. 9=alarm function when open. 10=case cleaning (pulse signal). 11=forced cooling at hot gas defrost, 12=night cover. 15=appliance shutdown	o02	1	1	1	1	1	1	1	1	1	1	0	15	0	
Network address	o03	1	1	1	1	1	1	1	1	1	1	0	240	0	
On/Off switch (Service Pin message) IMPORTANT! o61 must be set prior to o04 (used at LON 485 and DANBUSS only)	o04	1	1	1	1	1	1	1	1	1	1	0/Off	1/On	0/Off	
Access code 1 (all settings)	o05	1	1	1	1	1	1	1	1	1	1	0	100	0	
Used sensor type : 0=Pt1000, 1=Ptc1000,	o06	1	1	1	1	1	1	1	1	1	1	0/Pt	1/Ptc	0/Pt	
Max hold time after coordinated defrost	o16	1	1	1	1	1	1	1	1	1	1	0 min.	360 min.	20	
Select signal for display view. 54% (100%=S4, 0%=S3)	o17	1	1	1	1	1	1	1	1	1	1	0 %	100 %	100	
Pressure transmitter working range - min. value	o20	1	1	1	1	1	1	1	1	1	1	-1 bar	5 bar	-1	
Pressure transmitter working range - max. value	o21	1	1	1	1	1	1	1	1	1	1	6 bar	200 bar	12	
Refrigerant setting: 1=R12. 2=R22. 3=R134a. 4=R502. 5=R717. 6=R13. 7=R13b1. 8=R23. 9=R500. 10=R503. 11=R114. 12=R142b. 13=User defined. 14=R32. 15=R227. 16=R401A. 17=R507. 18=R402A. 19=R404A. 20=R407C. 21=R407A. 22=R407B. 23=R410A. 24=R170. 25=R290. 26=R600. 27=R600a. 28=R744. 29=R1270. 30=R417A. 31=R422A. 32=R413A. 33=R422D. 34=R427A. 35=R438A. 36=XP10. 37=R407F.	o30	1	1	1	1	1	1	1	1	1	1	0	37	0	

Continued	Code	1	2	3	4	5	6	7	8	9	10	Min.	Max.	Fac.	Actual
Input signal on DI2. Function: (0=not used. 1=status on DI2. 2=door function with alarm when open. 3=door alarm when open. 4=defrost start (pulse-signal). 5=ext. main switch 6=night operation 7=thermostat band changeover (activate r21). 8=alarm function when closed. 9=alarm function when open. 10=case cleaning (pulse signal). 11=forced cooling at hot gas defrost.). 12=night cover, 13=coordinated defrost). 15=appliance shutdown	o37	1	1	1	1	1	1	1	1	1	1	0	15	0	
Configuration of light function: 1=Light follows day /night operation, 2=Light control via data communication via 'o39', 3=Light control with a DI-input, 4=As "2", but light switch on and night cover will open if the network cut out for more than 15 minutes.	o38	1	1		1		1	1	1	1	1	1	4	1	
Activation of light relay (only if o38=2) On=light	o39	1	1		1		1	1	1	1	1	0/Off	1/On	0/Off	
Rail heat On time during day operations	o41		1	1	1	1		1		1	1	0 %	100 %	100	
Rail heat On time during night operations	o42		1	1	1	1		1		1	1	0 %	100 %	100	
Rail heat period time (On time + Off time)	o43		1	1	1	1		1		1	1	6 min.	60 min.	10	
Case cleaning. 0=no case cleaning. 1=Fans only. 2=All output Off.	*** o46	1	1	1	1	1	1	1	1	1	1	0	2	0	
Selection of EL diagram. See overview page 12 and 13	* o61	1	1	1	1	1	1	1	1	1	1	1	10	1	
Download a set of predetermined settings. See overview page 27.	* o62	1	1	1	1	1	1	1	1	1	1	0	6	0	
Access code 2 (partial access)	*** o64	1	1	1	1	1	1	1	1	1	1	0	100	0	
Replace the controllers factory settings with the present settings	o67	1	1	1	1	1	1	1	1	1	1	0/Off	1/On	0/Off	
Input signal on DI3. Function: (high voltage input) (0=not used. 1=status on DI2. 2=door function with alarm when open. 3=door alarm when open. 4=defrost start (pulse-signal). 5=ext. main switch 6=night operation, 7=thermostat band changeover (activate r21). 8=Not used. 9=Not used. 10=case cleaning (pulse signal). 11=forced cooling at hot gas defrost, 12=night cover. 13=Not used. 14=Refrigeration stopped (forced closing)). 15=appliance shutdown	o84	1	1	1	1	1	1	1	1	1	1	0	15	0	
Rail heat control 0=not used, 1=pulse control with timer function (o41 and o42), 2=pulse control with dew point function	o85		1	1	1	1		1		1	1	0	2	0	
Dew point value where the rail heat is minimum	o86		1	1	1	1		1		1	1	-10°C	50°C	8	
Dew point value where the rail heat is 100% on	o87		1	1	1	1		1		1	1	-9°C	50°C	17	
Lowest permitted rail heat effect in %	o88		1	1	1	1		1		1	1	0 %	100 %	30	
Time delay from "open door" refrigeration is started	o89	1	1	1	1	1	1	1	1	1	1	0 min.	240 min.	30	
Fan operation on stopped refrigeration (forced closing): 0 = Stopped (defrosting permitted) 1 = Running (defrosting permitted) 2 = Stopped (defrosting not permitted) 3 = Running (defrosting not permitted)	o90	1	1	1	1	1	1	1	1	1	1	0	3	1	
Definition of readings on lower button: 1=defrost stop temperature, 2=S6 temperature, 3=S3 temperature, 4=S4 temperature	o92	1	1	1	1	1	1	1	1	1	1	1	3	1	
Display of temperature 1= u56 Air temperature (set automatically to 1 at application 9) 2= u36 product temperature	o97	1	1	1	1	1	1	1	1	1	1	1	2	1	
Light and night blinds defined 0: Light is switch off and night blind is open when the main switch is off 1: Light and night blind is independent of main switch	o98	1	1	1	1	1	1	1	1	1	1	0	1	0	
Configuration of alarm relay The alarm relay will be activated upon an alarm signal from the following groups: 0 - Alarm relay not used 1 - High temperature alarms 2 - Low temperature alarms 4 - Sensor error 8 - Digital input enabled for alarm 16 - Defrosting alarms 32 - Miscellaneous 64 - Injection alarms The groups that are to activate the alarm relay must be set by using a numerical value which is the sum of the groups that must be activated. (E.g.: a value of 5 will activate all high temperature alarms and all sensor error.	P41	1		1	1					1	1	0	127	111	

Continued	Code	1	2	3	4	5	6	7	8	9	10	Min.	Max.	Fac.	Actual
Service															
Temperature measured with S5 sensor	u09	1	1	1	1	1	1	1	1	1	1				
Status on DI1 input. on/1=closed	u10	1	1	1	1	1	1	1	1	1	1				
Actual defrost time (minutes)	u11	1	1	1	1	1	1	1	1	1	1				
Temperature measured with S3 sensor	u12	1	1	1	1	1	1	1	1	1	1				
Status on night operation (on or off) 1=on	u13	1	1	1	1	1	1	1	1	1	1				
Temperature measured with S4 sensor	u16	1	1	1	1	1	1	1	1	1	1				
Thermostat temperature	u17	1	1	1	1	1	1	1	1						
Run time of thermostat (cooling time) in minutes	u18	1	1	1	1	1	1	1	1	1	1				
Temperature of evaporator outlet temp.	u20	1	1	1	1	1	1	1	1	1	1				
Superheat across evaporator	u21	1	1	1	1	1	1	1	1	1	1				
Reference of superheat control	u22	1	1	1	1	1	1	1	1	1	1				
Opening degree of AKV valve	** u23	1	1	1	1	1	1	1	1	1	1				
Evaporating pressure Po (relative)	u25	1	1	1	1	1	1	1	1	1	1				
Evaporator temperature To (Calculated)	u26	1	1	1	1	1	1	1	1	1	1				
Temperature measured with S6 sensor (product temperature)	u36	1	1	1	1	1	1	1	1		1				
Status on DI2 output. on/1=closed	u37	1	1	1	1	1	1	1	1	1	1				
Air temperature . Weighted S3 and S4	u56	1	1	1	1	1	1	1	1	1	1				
Measured temperature for alarm thermostat	u57	1	1	1	1	1	1	1	1	1	1				
Status on relay for cooling	** u58	1	1	1		1									
Status on relay for fan	** u59	1	1	1	1	1	1	1	1	1	1				
Status on relay for defrost	** u60	1	1	1	1	1		1	1	1	1				
Status on relay for railheat	** u61		1	1	1	1		1			1				
Status on relay for alarm	** u62	1		1	1					1					
Status on relay for light	** u63	1	1		1			1	1	1	1				
Status on relay for valve in suction line	** u64							1							
Status on relay for compressor 2	** u67					1									
Temperature measured with S5B sensor	u75										1				
Temperature measured with S3B sensor	u76										1	1			
Status on relay for hot gas- / drain valve	** u80							1							
Status on relay for heating element in drip tray	** u81							1							
Status on relay for night blinds	** u82								1						
Status on relay for defrost B	** u83										1				
Status on relay for heat function	** u84									1					
Readout of the actual rail heat effect	u85		1	1	1	1		1			1	1			
1: Thermostat 1 operating, 2: Thermostat 2 operating	u86	1	1	1	1	1	1	1	1	1	1				
Status on high voltage input DI3	u87	1	1	1	1	1	1	1	1	1	1				
Readout of thermostats actual cut in value	u90	1	1	1	1	1	1	1	1	1	1				
Readout of thermostats actual cut out value	u91	1	1	1	1	1	1	1	1	1	1				
Readout of status on the adaptive defrost 0: Off. Function is not activated and are zero set 1: Sensor error or S3/S4 are reversed. 2: Tuning is in progress 3: Normal 4: Light build-up of ice 5: Medium build-up of ice 6: Heavy build-up of ice	U01	1	1	1	1	1	1	1	1	1	1				
Number of defrosts carried out since the initial power up or since the resetting of the function	U10	1	1	1	1	1	1	1	1	1	1				
Number of defrosts skipped since the initial power up or since the resetting of the function	U11	1	1	1	1	1	1	1	1	1	1				
Measured temperature for alarm thermostat in section B	U34										1	1			
Air temperature in section B	U35										1	1			

*) Can only be set when regulation is stopped (r12=0)

**) Can be controlled manually, but only when r12=-1

**) With access code 2 the access to these menus will be limited

Factory settings are indicated for standard units. Other code numbers have customized settings.

Fault message		
In an error situation the LED's on the front will flash and the alarm relay will be activated. If you push the top button in this situation you can see the alarm report in the display.		
There are two kinds of error reports - it can either be an alarm occurring during the daily operation, or there may be a defect in the installation.		
A-alarms will not become visible until the set time delay has expired.		
E-alarms, on the other hand, will become visible the moment the error occurs. (An A alarm will not be visible as long as there is an active E alarm).		
Here are the messages that may appear:		
Code / Alarm text via data communication	Description	Alarm relay groups (P41)
A1/--- High t.alarm	High temperature alarm	1
A2/--- Low t. alarm	Low temperature alarm	2
A4/--- Door alarm	Door alarm	8
A5/--- Max hold time	The "o16" function is activated during a coordinated defrost	16
A10/--- Inject prob.	Control problem	64
A11/--- No Rfg. sel.	No refrigerant selected	64
A13/--- High temp S6	Temperature alarm. High S6	1
A14/--- Low temp S6	Temperature alarm. Low S6	2
A15/--- DI1 alarm	DI1 alarm	8
A16/--- DI2 alarm	DI2 alarm	8
A45/--- Standby mode	Standby position (stopped refrigeration via r12 or DI input)	-
A59/--- Case clean	Case cleaning. Signal from DI input	-
A70/--- High temp S3B	High temperature alarm, B section	1
A71/--- Low temp S3B	Low temperature alarm, B section	2
--- AD fault	Error in the adaptive defrost function	16
--- AD Iced	Evaporator is iced up. Reduction of air flow	16
--- AD not defr.	Defrost of evaporator is not satisfactory	16
--- AD flashgas.	Flash gas is formed at the valve	16
E1/--- Ctrl. error	Faults in the controller	32
E6/--- RTC error	Check clock	32
E20/--- Pe error	Error on pressure transmitter Pe	64
E24/--- S2 error	Error on S2 sensor	4
E25/--- S3 error	Error on S3 sensor	4
E26/--- S4 error	Error on S4 sensor	4
E27/--- S5 error	Error on S5 sensor	4
E28/--- S6 error	Error on S6 sensor	4
E34/--- S3 error B	Error on S3B sensor	4
E37/--- S5 error B	Error on S5B sensor	4
---/--- Max Def.Time	Defrost stopped based on time instead of, as wanted, on temperature	16

Operating status		(Measurement)
The controller goes through some regulating situations where it is just waiting for the next point of the regulation. To make these "why is nothing happening" situations visible, you can see an operating status on the display. Push briefly (1s) the upper button. If there is a status code, it will be shown on the display. The individual status codes have the following meanings:		Ctrl. state: (Shown in all menu displays)
Normal regulation	S0	0
Waiting for end of the coordinated defrost	S1	1
When the compressor is operating it must run for at least x minutes.	S2	2
When the compressor is stopped, it must remain stopped for at least x minutes.	S3	3
The evaporator drips off and waits for the time to run out	S4	4
Refrigeration stopped by main switch. Either with r12 or a DI-input	S10	10
Refrigeration stopped by thermostat	S11	11
Defrost sequence. Defrost in progress	S14	14
Defrost sequence. Fan delay — water attaches to the evaporator	S15	15
Refrigeration stopped due to open ON input or stopped regulation	S16	16
Door is open. DI input is open	S17	17
Melt function in progress. Refrigeration is interrupted	S18	18
Modulating thermostat control	S19	19
Emergency cooling due to sensor error *)	S20	20
Regulation problem in the injections function	S21	21
Start-up phase 2. Evaporator being charged	S22	22
Adaptive control	S23	23
Start-up phase 1. Signal reliability from sensors is controlled	S24	24
Manual control of outputs	S25	25
No refrigerant selected	S26	26
Case cleaning	S29	29
Forced cooling	S30	30
Delay on outputs during start-up	S32	32
Heat function r36 is active	S33	33
Appliance shutdown	S45	45
<i>Other displays:</i>		
The defrost temperature cannot be displayed. There is stop based on time	non	
Defrost in progress / First cooling after defrost	-d-	
Password required. Set password	PS	
Regulation is stopped via main switch	OFF	

*) Emergency cooling will take effect when there is lack of signal from a defined S3 or S4 sensor. The regulation will continue with a registered average cutin frequency. There are two registered values – one for day operation and one for night operation.

Data communication

The importance of individual alarms can be defined with a setting. The setting must be carried out in the group "Alarm destinations"

Settings from System manager	Settings from AKM (AKM destination)	Log	Alarm relay			Send via Network
			Non	High	Low-High	
High	1	X		X	X	X
Middle	2	X			X	X
Low	3	X			X	X
Log only		X				
Disabled						