



REFRIGERATION AND
AIR CONDITIONING

INSTRUCTIONS

EKC 202D1



084R8022

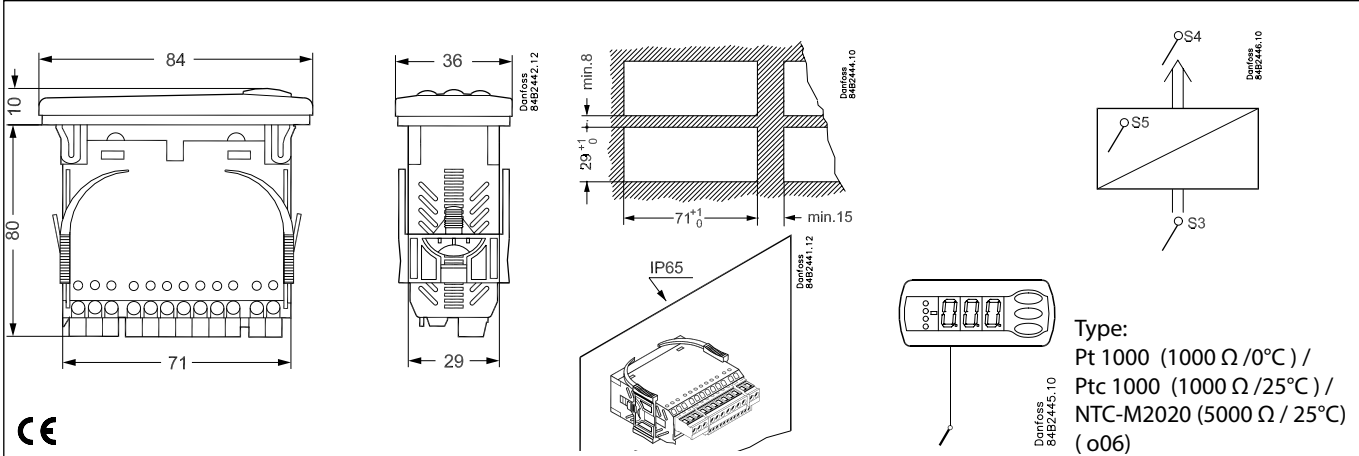

Type:
Pt 1000 (1000 Ω / 0°C) /
Pt_c 1000 (1000 Ω / 25°C) /
NTC-M2020 (5000 Ω / 25°C)
(o06)

084R8022

$t_{amb} = 0 - +55^{\circ}\text{C}$

230 V a.c.

2.5 VA

10V < U < 256V

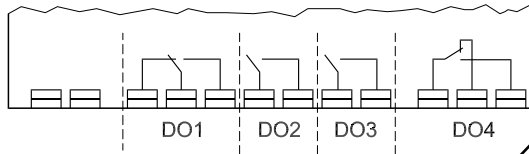

	CE (250 V a.c.)
DO1. Refrigeration *	10 (6) A
DO2. Defrost *	10 (6) A
DO3. Fan *	6 (3) A
DO4. Alarm, light or rail heat *	4 (1) A Min. 100 mA**

* DO1 and DO2 are 16 A relays. DO3 and DO4 are 8 A relays.
Max. load must be kept.
** Gold plating ensures make function with small contact loads

Coordinated defrost

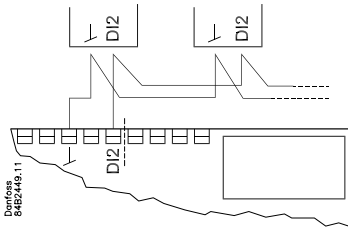

Data communication LON RS485:

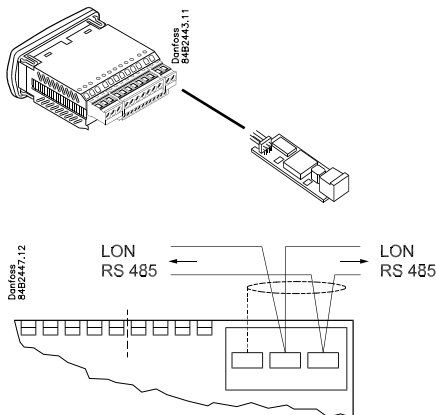

With S5B & external display

With S5B

With external display

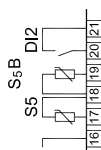
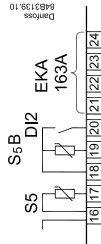

o61 =

1

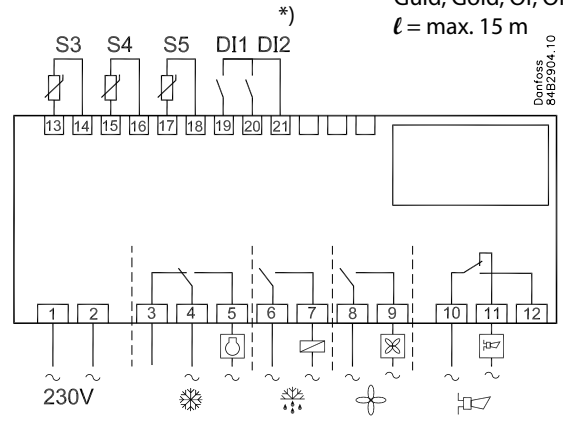

2

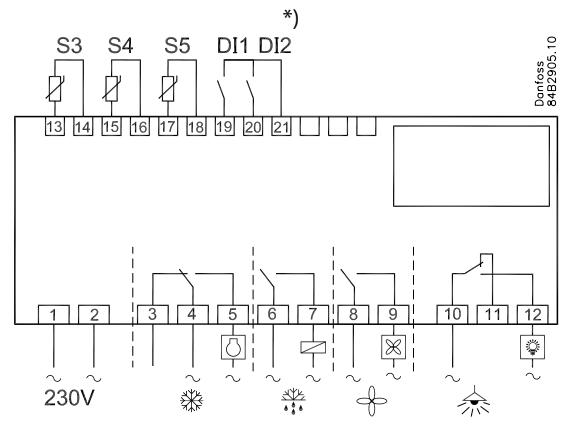

3

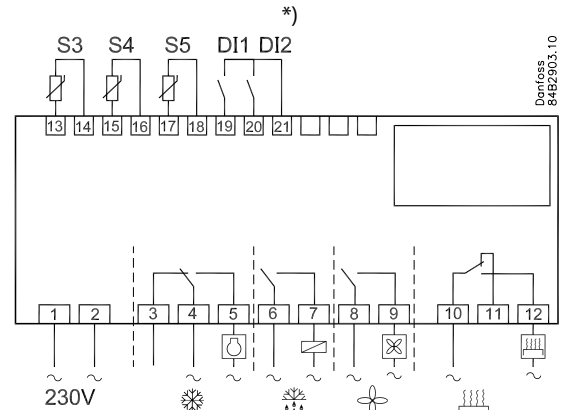

*) DI1, DI2:
AU:
Guld, Gold, Or, Oro
 $l = \text{max. } 15 \text{ m}$

Dansk

SW = 1.5x

Parametre	Koder	EL-diagramnummer (side 1)			Min.-værdi	Max.-værdi	Fabriksindstilling	Aktuel indstilling
		1	2	3				
Funktion								
Normal drift								
Temperatur (setpunkt)		---			-50.0°C	50.0°C	2.0°C	
Termostat								
Differens	***	r01			0.1 K	20.0 K	2.0 K	
Max. begrænsning af setpunktsindstilling	***	r02			-49.0°C	50.0°C	50.0°C	
Min. begrænsning af setpunktsindstilling	***	r03			-50.0°C	49.0°C	-50.0°C	
Justering af temperaturvisning		r04			-20.0 K	20.0 K	0.0 K	
Temperaturenhed (°C/°F)		r05			°C	°F	°C	
Korrektion af signalet fra S4		r09			-10.0 K	10.0 K	0.0 K	
Korrektion af signalet fra S3		r10			-10.0 K	10.0 K	0.0 K	
Manuel service (-1), Stop regulering (0), Start regulering (1)		r12			-1	1	0	
Referenceforskydning under natdrift		r13			-10.0 K	10.0 K	0.0 K	
Definition og evt. vægning af termostadfølere - S4% (100%=S4, 0%=S3)		r15			0%	100%	100%	
Aktivisering af referenceforskydning r40		r39			OFF	ON	OFF	
Værdi for referenceforskydning (aktiveres via r39 eller DI)		r40			-50.0 K	50.0 K	0.0 K	
Valg af termostadføler S4% under natdrift med natlåg		r61			0%	100%	100%	
Temperaturdifferens for natlåg (0 K = ingen detektering)		r75			0 K	20 K	0 K	
Alarm								
Forsinkelse på temperaturalarm		A03			0 min	240 min	30 min	
Forsinkelse på døralarm	***	A04			0 min	240 min	60 min	
Forsinkelse på temperaturalarm efter afrimning		A12			0 min	240 min	90 min	
Høj alarmgrænse	***	A13			-50.0°C	50.0°C	8.0°C	
Lav alarmgrænse	***	A14			-50.0°C	50.0°C	-30.0°C	
Alarm forsinkelse DI1		A27			0 min	240 min	30 min	
Alarm forsinkelse DI2		A28			0 min	240 min	30 min	
Definition af alarmføler 1: Kombination af S3 og S4 (A36, A13 og A14 skal indstilles) 2: Separate værdier for S3 og S4 (A13, A14, A56 og A57 skal indstilles)		A33			1	2	1	
Signal til alarmtermostaten. (100%=S4, 0%=S3)		A36			0%	100%	100%	
Høj alarmgrænse for S3		A56			-50.0°C	50.0°C	8.0°C	
Lav alarmgrænse for S3		A57			-50.0°C	50.0°C	-30.0°C	
Kompressor								
Min. ON-tid		c01			0 min	30 min	0 min	
Min. OFF-tid		c02			0 min	30 min	0 min	
Kompressorrelæ 1 skal koble modsat (NC-funktion)		c30			0 OFF	1 ON	0 OFF	
Afrimning								
Afrimningsmetode (ingen/EL/GAS/BRINE)		d01			no	bri	EL	
Afrimnings-stoptemperatur		d02			0.0°C	25.0°C	6.0°C	
Interval mellem afrimningsstarter		d03			0 hours	240 hours	8 hours	
Max. afrimningsvarighed		d04			0 min	180 min	45 min	
Tidsforskydning på afrimningsindkoblingen ved opstart		d05			0 min	240 min	0 min	
Afdrypningstid		d06			0 min	60 min	0 min	
Forsinkelse på ventilatorstart efter afrimning		d07			0 min	60 min	0 min	
Ventilator-starttemperatur		d08			-50.0°C	0.0°C	-50.0°C	
Ventilator indkoblet under afrimning 0: stoppet. 1: Kører. 2: Kører under pump down og afrimning		d09			0	2	1	
Afrimningsføler (0=tid, 1=S5, 2=S4)		d10			0	2	0	
Pump down forsinkelse		d16			0 min	60 min	0 min	
Max. opsummeret køletid imellem to afrimninger		d18			0 hours	48 hours	0 hours	
Behovstyret afrimning - S5 temperaturrens tilladte variation ved isopbygning. På centralanlæg vælges 20 (=off)		d19			0.0 K	20.0 k	20.0 K	
Minimum afrimningstid		d24			0 min	180 min	0 min	
Ventilator								
Ventilatorstop ved udkoblet kompressor		F01			no	yes	no	
Forsinkelse af ventilatorstop		F02			0 min	30 min	0 min	
Ventilatorstop temperatur (S5)		F04			-50.0°C	50.0°C	50.0°C	
Realtidsur								
Seks starttidspunkter for afrimning. Indstilling af timer. 0=OFF		t01-t06			0 hours	23 hours	0 hours	
Seks starttidspunkter for afrimning. Indstilling af minutter 0=OFF		t11-t16			0 min	59 min	0 min	
Ur - Timeindstilling	***	t07			0 hours	23 hours	0 hours	
Ur - Minutindstilling	***	t08			0 min	59 min	0 min	
Ur - Indstilling af dato	***	t45			1	31	1	
Ur - Indstilling af måned	***	t46			1	12	1	
Ur - Indstilling af år	***	t47			0	99	0	

Indstil:

1 Åbn parameter r12 og stop reguleringen

2 Vælg elforbindelse ud fra tegningerne side 1

3 Åbn parameter o61 og indstil elforbindelsesnummeret heri

4 Vælg derefter et sæt af forudindstillinger fra hjælpeskemaet

5 Åbn parameter o62 og indstil nummeret for sættet af forudindstillinger. Herefter overføres de få udvalgte indstillinger til menuen

6 Reguleringen er nu startet (r12 blev indstillet til 1 i punkt 5)

7 Se oversigten over fabriksindstillinger igennem. — Foretag de nødvendige ændringer i de respektive parametre

8 Ved netværk. Indstil adressen i o03 og send derefter adressen til gateway/systemenheden med indstillingen o04.

Diverse							
Forsinkelse af udgangssignaler efter opstart		o01			0 s	600 s	5 s
Indgangssignal på DI1. Funktion: 0=ikke anvendt, 1=status på DI1. 2=dørfunktion med alarm ved åben. 3=døralarm ved åben. 4=afrimningsstart (pulssignal). 5=ekstern hovedafbryder. 6=natdrift. 7=skift reference (r40 aktiveres). 8=alarmfunktion ved sluttet. 9=alarmfunktion ved åben. 10=møbelrengøring (pulssignal). 11=Tvangskøling. 12=S5B		o02			0	12	0
Netværksadresse		o03			0	240	0
On/Off omskifter (Service Pin meddelelse)		o04			OFF	ON	OFF
VIGTIGT! o61 skal indstilles før o04							
Adgangskode 1 (samtlige indstillinger)		o05			0	100	0
Anvendt føler type (Pt /PTC/NTC)		o06			Pt	ntc	Pt
Display step = 0.5 (normal 0.1 ved Pt føler)		o15			no	yes	no
Max holdetid efter koordineret afrimning		o16			0 min	60 min	20 min
Vælg signal til displayvisningen. 54% (100%=S4, 0%=S3)		o17			0%	100%	100%
Indgangssignal på DI2. Funktion: 0=ikke anvendt. 1=status på DI2. 2=dørfunktion med alarm ved åben. 3=døralarm ved åben. 4=afrimningsstart (pulstryk). 5=ekstern hovedafbryder. 6=natdrift. 7=skift reference (r40 aktiveres). 8=alarmfunktion ved sluttet. 9=alarmfunktion ved åben. 10=møbelrengøring (pulstryk). 11=Tvangskøling. 12=koordineret afrimning		o37			0	12	0
Konfiguration af lysfunktionen (relæ 4) 1=ON under dagdrift. 2=ON / OFF via datakommunikation. 3=ON følger DI-funktionen, når DI er valgt til dørfunktion eller til døralarm		o38			1	3	1
Aktivering af lysrelæ (kun hvis o38=2)		o39			OFF	ON	OFF
Kantvarme On-tid under dagdrift		o41			0%	100%	100%
Kantvarme On-tid under natdrift		o42			0%	100%	100%
Kantvarme periodetid (On tid + Off tid)		o43			6 min	60 min	10 min
Møbelrengøring. 0=ingen møbelrengøring 1= kun ventilatorer. 2 Alle udgange er OFF	***	o46			0	2	0
Valg af EL-diagram. Se oversigten side 1.	*	o61	1	2	3	1	1
Overfør et sæt af forudindstillinger. Se oversigten på side 4.	*	o62			0	10	0
Adgangskode 2 (delvis adgang)	***	o64			0	100	0
Gem apparatets nuværende indstillinger på programmeringsnøglen. Vælg selv nummer.		o65			0	25	0
Hent et sæt indstillinger fra programmeringsnøglen (tidligere gemt via o65 funktionen)		o66			0	25	0
Overskriv regulatorens fabriksindstillinger med de nuværende indstillinger		o67			OFF	On	OFF
Service							
Statuskoder		S0-S33					
Temperaturen målt med S5 føleren	***	u09					
Status på DI1 indgangen. 1=sluttet		u10					
Temperaturen målt med S3 føleren	***	u12					
Status på natdrift (on eller off) 1=sluttet	***	u13					
Temperaturen målt med S4 føleren	***	u16					
Termostattemperaturen		u17					
Aflæse den øjeblikkelige reguleringsreference		u28					
Status på DI2 udgangen. 1=sluttet		u37					
Temperaturen der udlæses på displayet		u56					
Målt temperatur til alarmtermostaten		u57					
Status på relæet til køling	**	u58					
Status på relæet til ventilator	**	u59					
Status på relæet til afrimning	**	u60					
Status på relæet til kantvarme	**	u61					
Status på relæet til alarm	**	u62					
Status på relæet til lys	**	u63					
Temperaturen målt med S5B føleren	***	u75					
Status på natlågdetektering (On = natlåg er detekteret)		U08					

*) Kan kun indstilles, når reguleringen er stoppet (r12=0)

***) Kan styres manuelt, men kun når r12 = -1

****) Med adgangskode 2 begrænses adgangen til disse menuer

Visning af fejlkode	
E 1	Fejl i regulator
E 6	Batteriet skal skiftes + kontroller ur
E 25	S3 føler fejl
E 26	S4 føler fejl
E 27	S5 føler fejl
E 37	S5B føler fejl
Visning af alarmkode	
A 1	Høj-temperatur alarm
A 2	Lav-temperatur alarm
A 4	Dør-alarm
A 5	Max. Hold time
A 8	Høj Temp. Alarm S3
A 9	Lav. Temp. Alarm S3
A 15	DI 1 alarm
A 16	DI 2 alarm
A 45	Standby mode
A 59	Møbelrengøring
A 81	Forbyttet S3 og S4 følere?
Visning af statuskode	
S0	Der reguleres
S1	Venter på at den koordinerede afrimning afsluttes
S2	ON-tid Kompressor
S3	OFF-tid kompressor
S4	Afdrypningstid
S10	Køling stoppet af hovedafbryder
S11	Køling stoppet af termostat
S14	Afrimningssekvens. Afrimer
S15	Afrimningssekvens. Ventilatorforsinkelse
S17	Dør åben (åben DI indgang)
S20	Nødkøling
S25	Manuel regulering af udgange
S29	Møbelrengøring
S30	Tvangskøling
S32	Forsinkelse af udgange ved opstart
non	Afrimningstemperaturen kan ikke vises. Der stoppes på tid
-d-	Afrimningen er igang
PS	Password er påkrævet

Fabriksindstilling

Hvis du får behov for at vende tilbage til de fabriksindstillede værdier, kan det ske således:

- Afbryd forsyningsspændingen til regulatoren

- Hold den øverste og nederste knap inde samtidig med at du igen tilslutter forsyningsspændingen.

Overfør et sæt af forudindstillinger. o62 =	1	2	3	4	5	6	7	8	9	10	
Funktion / Kode											
Normal drift											
Temperatur (setpunkt)	---	-8.0°C	-32.0°C	-30.0°C	-32.0°C	-28.0°C	-28.0°C	-2.0°C	-1.5°C	0.5°C	-2.0°C
Termostat											
Differens	r01	4.0 K	4.0 K	1.0 K	4.0 K	1.0 K	1.0 K	1.0 K	1.0 K	1.0 K	2.0 K
Max. begrænsning af setpunktsindstilling	r02	-5.0°C	-28.0°C	-28.0°C	-28.0°C	-25.0°C	-25.0°C	5.0°C	6.0°C	4.0°C	50.0°C
Min. begrænsning af setpunktsindstilling	r03	-10.0°C	-34.0°C	-34.0°C	-34.0°C	-50.0°C	-50.0°C	-10.0°C	-2.0°C	-1.0°C	-50.0°C
Manuel service, Stop regulering, Start regulering	r12	1	1	1	1	1	1	1	1	1	0
Referencforskydning under natdrift	r13	0	0	0	0	0	0	0	3 K	3 K	0
Værdi for referencforskydning	r40	0	0	0	0	6 K	0	0	-1.5 K	0.5 K	0
Valg af termostatføler 54% under natdrift med natlåg	r61	0	0	0	100%	0	0	0	0	0	100%
Temperaturdifferens for natlåg	r75	0	0	0	0	0	0	0	3 K	3 K	0
Alarm											
Forsinkelse på temperaturalarm	A03	30 min	30 min	30 min	30 min	10 min	10 min	30 min	10 min	10 min	30 min
Forsinkelse på temperaturalarm efter afrimning	A12	60 min	60 min	60 min	60 min	35 min	35 min	60 min	45 min	45 min	90 min
Høj alarmgrænse	A13	13.0°C	-11.0°C	-11.0°C	-11.0°C	-15.0°C	-15.0°C	10.0°C	2.0°C	5.0°C	8.0°C
Lav alarmgrænse	A14	-8.0°C	-32.0°C	-32.0°C	-35.0°C	-50.0°C	-50.0°C	-10.0°C	-50.0°C	-50.0°C	-30.0°C
Definition af alarmføler	A33	1	1	1	1	2	1	1	1	1	1
Signal til alarmtermostaten, 54%	A36	0	0	0	100%	0	100%	0	100%	100%	100%
Høj alarmgrænse for S3	A56	13.0°C	-11.0°C	-11.0°C	-11.0°C	-16.0°C	-15.0°C	10.0°C	50.0°C	50.0°C	8.0°C
Lav alarmgrænse for S3	A57	-8.0°C	-32.0°C	-32.0°C	-35.0°C	-50.0°C	-50.0°C	-10.0°C	-50.0°C	-50.0°C	-30.0°C
Kompressor											
Kompressorrelæ 1 skal koble modsat (NC-funktion)	c30	0	0	0	0	0	0	0	1	1	0
Afrimning											
Afrimnings-stoptemperatur	d02	5.0°C	5.0°C	5.0°C	5.0°C	5.0°C	15.0°C	7.0°C	10.0°C	10.0°C	6.0°C
Interval mellem afrimningsstarter	d03	12 hours	12 hours	48 hours	12 hours	24 hours	24 hours	6 hours	4 hours	4 hours	8 hours
Max. afrimningsvarighed	d04	45 min	45 min	45 min	45 min	60 min	45 min	40 min	35 min	35 min	45 min
Afdrypningsstid	d06	0 min	2 min	2 min	2 min	10 min	10 min	0 min	0 min	0 min	0 min
Forsinkelse på ventilatorstart efter afrimning	d07	0 min	3 min	0 min	3 min	5 min	5 min	0 min	0 min	0 min	0 min
Ventilator indkoblet under afrimning	d09	Yes	No	Yes	No	No	No	Yes	Yes	Yes	Yes
Afrimningsstopføler	d10	0	0	0	0	0	0	0	S4	S4	0
Diverse											
Forsinkelse af udgangssignaler efter opstart	o01	5 s	5 s	5 s	5 s	5 s	5 s	5 s	0	0	5s
Anvendt følerstype (Pt /PTC/NTC)	o06	NTC	NTC	NTC	NTC	NTC	NTC	NTC	NTC	NTC	Pt
Display step = 0,5°C	o15	Yes	Yes	Yes	Yes	Yes	Yes	Yes	No	No	No
Max holdetid efter koordineret afrimning	o16	20 min	20 min	25 min	25 min	15 min	15 min	20 min	30 min	30 min	20 min
Vælg signal til displayvisningen. 54%	o17	0	0	0	100%	0	100%	0	0	0	100%
Indgangssignal på DI2	o37	12	12	12	12	12	12	12	12	12	0
Kantvarme On-tid under dagdrift	o41	100%	100%	100%	100%	100%	100%	100%	0	0	100%
Kantvarme On-tid under natdrift	o42	100%	100%	100%	100%	100%	100%	100%	0	0	100%

Knapperne

Indstille en menu

- Tryk på den øverste knap til der vises en parameter
- Tryk på øverste eller nederste knap og find hen til den parameter, du vil indstille
- Tryk på den midterste knap indtil værdien for parameteren vises
- Tryk på øverste eller nederste knap og find den nye værdi
- Tryk igen på den midterste knap for at fastlåse værdien.

Udkoble alarmrelæ / se alarmkode

- Kort tryk på den øverste knap

Indstille temperaturen

- Tryk på den midterste knap til temperaturværdien vises
- Tryk på øverste eller den nederste knap og find den nye værdi
- Tryk på den midterste knap for at afslutte indstillingen.

Aflæse temperaturen ved afrimningsføleren

- Kort tryk på den nederste knap
- Manuel start eller stop af en afrimning
- Tryk på den nederste knap i 4 sekunder.

LED

Lysdiode

 = køling

 = afrimning

 = ventilator i gang

Blinker hurtigt ved alarm

English

SW = 1.5x

Parameters	EL-diagram number (page 1)			Min.-value	Max.-value	Factory setting	Actual setting
	Codes	1	2				
Function							
Normal operation							
Temperature (set point)	---			-50.0°C	50.0°C	2.0°C	
Thermostat							
Differential	***	r01		0.0 K	20.0K	2.0 K	
Max. limitation of setpoint setting	***	r02		-49.0°C	50°C	50.0°C	
Min. limitation of setpoint setting	***	r03		-50.0°C	49.0°C	-50.0°C	
Adjustment of temperature indication		r04		-20.0 K	20.0 K	0.0 K	
Temperature unit (°C/°F)		r05		°C	°F	°C	
Correction of the signal from S4		r09		-10.0 K	+10.0 K	0.0 K	
Correction of the signal from S3		r10		-10.0 K	+10.0 K	0.0 K	
Manual service, stop regulation, start regulation (-1, 0, 1)		r12		-1	1	0	
Displacement of reference during night operation		r13		-10.0 K	10.0 K	0.0 K	
Definition and weighting, if applicable, of thermostat sensors - S4% (100%=S4, 0%=S3)		r15		0%	100%	100%	
Activation of reference displacement r40		r39		OFF	ON	OFF	
Value of reference displacement (activate via r39 or DI)		r40		-50.0 K	50.0 K	0.0 K	
Thermostat sensor S4% can be selected under night operation with night time cover.		r61		0%	100%	100%	
Temperature difference for night time cover (0 K = not detected)		r75		0 K	20 K	0 K	
Alarm							
Delay for temperature alarm		A03		0 min	240 min	30 min	
Delay for door alarm	***	A04		0 min	240 min	60 min	
Delay for temperature alarm after defrost		A12		0 min	240 min	90 min	
High alarm limit	***	A13		-50.0°C	50.0°C	8.0°C	
Low alarm limit	***	A14		-50.0°C	50.0°C	-30.0°C	
Alarm delay DI1		A27		0 min	240 min	30 min	
Alarm delay DI2		A28		0 min	240 min	30 min	
Definition of alarm sensor 1: Combination of S3 and S4 (A36, A13 and A14 must be set) 2: Separate values for S3 and S4 (A13, A14, A56 and A57 must be set)		A33		1	2	1	
Signal for alarm thermostat. S4% (100%=S4, 0%=S3)		A36		0%	100%	100%	
High alarm limit for S3		A56		-50.0°C	50.0°C	8.0°C	
Low alarm limit for S3		A57		-50.0°C	50.0°C	-30.0°C	
Compressor							
Min. ON-time		c01		0 min	30 min	0 min	
Min. OFF-time		c02		0 min	30 min	0 min	
Compressor relay 1 must cutin and out inversely (NC-function)		c30		0 OFF	1 ON	0 OFF	
Defrost							
Defrost method (none/EL/GAS/BRINE)		d01		no	bri	EL	
Defrost stop temperature		d02		0.0°C	25.0°C	6.0°C	
Interval between defrost starts		d03		0 hours	240 hours	8 hours	
Max. defrost duration		d04		0 min	180 min	45 min	
Displacement of time on cutin of defrost at start-up		d05		0 min	240 min	0 min	
Drip off time		d06		0 min	60 min	0 min	
Delay for fan start after defrost		d07		0 min	60 min	0 min	
Fan start temperature		d08		-50.0°C	0.0°C	-50.0°C	
Fan cutin during defrost 0: Stopped. 1: Running 2: Running during pump down and defrost		d09		0	2	1	
Defrost sensor (0=time, 1=S5, 2=S4)		d10		0	2	0	
Pump down delay		d16		0 min	60 min	0 min	
Max. aggregate refrigeration time between two defrosts		d18		0 hours	48 hours	0 hours	
Defrost on demand - S5 temperature's permitted variation during frost build-up. On central plant choose 20 K (=off)		d19		0.0 K	20.0 k	20.0 K	
Minimum defrost time		d24		0 min	180 min	0 min	
Fan							
Fan stop at cutout compressor		F01		no	yes	no	
Delay of fan stop		F02		0 min	30 min	0 min	
Fan stop temperature (S5)		F04		-50.0°C	50.0°C	50.0°C	
Real time clock							
Six start times for defrost. Setting of hours. 0=OFF		t01-t06		0 hours	23 hours	0 hours	
Six start times for defrost. Setting of minutes. 0=OFF		t11-t16		0 min	59 min	0 min	
Clock - Setting of hours	***	t07		0 hours	23 hours	0 hours	
Clock - Setting of minute	***	t08		0 min	59 min	0 min	
Clock - Setting of date	***	t45		1	31	1	
Clock - Setting of month	***	t46		1	12	1	
Clock - Setting of year	***	t47		0	99	0	

Setting:

- 1 Open parameter r12 and stop the regulation**
- 2 Select electric connection based on the drawings on page 1**
- 3 Open parameter o61 and set the electric connection number in it**
- 4 Now select one of the preset settings from the table**
- 5 Open parameter o62 and set the number for the array of presettings. The few selected settings will now be transferred to the menu.**
- 6 Regulation is now started (r12 was set to 1 in point 5)**
- 7 Go through the survey of factory settings. Make any necessary changes in the respective parameters.**
- 8 For network. Set the address in o03 and then transmit it to the gateway/system unit with setting o04.**

Miscellaneous							
Delay of output signals after start-up		o01			0 s	600 s	5 s
Input signal on DI1. Function: 0=not used. 1=status on DI1. 2=door function with alarm when open. 3=door alarm when open. 4=defrost start (pulse signal). 5=ext.main switch. 6=night operation 7=change reference (activate r40). 8=alarm function when closed. 9=alarm function when open. 10=case cleaning (pulse signal). 11=forced cooling. 12=S5B		o02			1	12	0
Network address		o03			0	240	0
On/Off switch (Service Pin message) IMPORTANT! o61 must be set prior to o04		o04			OFF	ON	OFF
Access code 1 (all settings)		o05			0	100	0
Used sensor type (Pt /PTC/NTC)		o06			Pt	ntc	Pt
Display step = 0.5 (normal 0.1 at Pt sensor)		o15			no	yes	no
Max hold time after coordinated defrost		o16			0 min	60 min	20 min
Select signal for display view. S4% (100%=S4, 0%=S3)		o17			0%	100%	100%
Input signal on DI2. Function: (0=not used. 1=status on DI2. 2=door function with alarm when open. 3=door alarm when open. 4=defrost start (pulse-pressure). 5=ext. main switch 6=night operation 7=change reference (activate r40). 8=alarm function when closed. 9=alarm function when open. 10=case cleaning (pulse pressure). 11=forced cooling . 12=coordinated defrost)		o37			0	12	0
Configuration of light function (relay 4) 1=ON during day operation. 2=ON / OFF via data communication. 3=ON follows the DI-function, when DI is selected to door function or to door alarm		o38			1	3	1
Activation of light relay (only if o38=2)		o39			OFF	ON	OFF
Rail heat On time during day operations		o41			0%	100%	100%
Rail heat On time during night operations		o42			0%	100%	100%
Rail heat period time (On time + Off time)		o43			6 min	60 min	10 min
Case cleaning. 0=no case cleaning. 1=Fans only. 2=All output Off.	***	o46			0	2	0
Selection of EL diagram. See overview page 1	*	o61	1	2	3	1	3
Transfer a set of pre-settings See overview page 7.	*	o62				0	10
Access code 2 (partly access)	***	o64				0	100
Save the controllers present settings to the programming key. Select your own number.		o65				0	25
Load a set of settings from the programming key (previously saved via o65 function)		o66				0	25
Replace the controllers factory settings with the present settings		o67				OFF	On
Service							
Status codes		S0-S33					
Temperature measured with S5 sensor	***	u09					
Status on DI1 input. on/1=closed		u10					
Temperature measured with S3 sensor	***	u12					
Status on night operation (on or off) 1=closed	***	u13					
Temperature measured with S4 sensor	***	u16					
Thermostat temperature		u17					
Read the present regulation reference		u28					
Status on DI2 output. on/1=closed		u37					
Temperature shown on display		u56					
Measured temperature for alarm thermostat		u57					
Status on relay for cooling	**	u58					
Status on relay for fan	**	u59					
Status on relay for defrost	**	u60					
Status on relay for rail heat	**	u61					
Status on relay for alarm	**	u62					
Status on relay for light	**	u63					
Temperature measured with S5B sensor	***	u75					
Status of night time cover detection (On = night time cover has been detected)		U08					

*) Can only be set when regulation is stopped (r12=0)
 **) Can be controlled manually, but only when r12=-1
 ***) With access code 2 the access to these menus will be limited

Fault code display	
E 1	Fault in controller
E 6	Change battery + check clock
E 25	S3 sensor error
E 26	S4 sensor error
E 27	S5 sensor error
E 37	S5B sensor error
Alarm code display	
A 1	High temperature alarm
A 2	Low temperature alarm
A 4	Door alarm
A 5	Max. Hold time
A 8	High Temp. Alarm S3
A 9	Low Temp. Alarm S3
A 15	DI 1 alarm
A 16	DI 2 alarm
A 45	Standby mode
A 59	Case cleaning
A 81	Switched S3 and S4 sensors?
Status code display	
S 0	Regulating
S 1	Waiting for end of the coordinated defrost
S 2	ON-time Compressor
S 3	OFF-time Compressor
S 4	Drip-off time
S 10	Refrigeration stopped by main switch
S 11	Refrigeration stopped by thermostat
S 14	Defrost sequence. Defrosting
S 15	Defrost sequence. Fan delay
S 17	Door open (open DI input)
S 20	Emergency cooling
S 25	Manual control of outputs
S 29	Case cleaning
S 30	Forced cooling
S 32	Delay of output at start-up
non	The defrost temperature cannot be displayed. There is stop based on time
-d-	Defrost in progress
PS	Password required

Factory setting

If you need to return to the factory-set values, it can be done in this way:

- Cut out the supply voltage to the controller
- Keep upper and lower button depressed at the same time as you reconnect the supply voltage

Transfer a set of pre-settings. o62 =	1	2	3	4	5	6	7	8	9	10	
Function / Code											
Normal operation											
Temperature (set point)	---	-8.0°C	-32.0°C	-30.0°C	-32.0°C	-28.0°C	-28.0°C	-2.0°C	-1.5°C	0.5°C	-2.0°C
Thermostat											
Differential	r01	4.0 K	4.0 K	1.0 K	4.0 K	1.0 K	1.0 K	1.0 K	1.0 K	1.0 K	2.0 K
Max. limitation of setpoint setting	r02	-5.0°C	-28.0°C	-28.0°C	-28.0°C	-25.0°C	-25.0°C	5.0°C	6.0°C	4.0°C	50.0°C
Min. limitation of setpoint setting	r03	-10.0°C	-34.0°C	-34.0°C	-34.0°C	-50.0°C	-50.0°C	-10.0°C	-2.0°C	-1.0°C	-50.0°C
Manual service, stop regulation, start regulation (-1, 0, 1)	r12	1	1	1	1	1	1	1	1	1	0
Reference displacement during night operation	r13	0	0	0	0	0	0	0	3 K	3 K	0
Value of reference displacement	r40	0	0	0	0	6 K	0	0	-1.5 K	0.5 K	0
Selection of thermostat sensor S4% during night operation with night blinds	r61	0	0	0	100%	0	0	0	0	0	100%
Temperature difference for night blinds	r75	0	0	0	0	0	0	0	3 K	3 K	0
Alarm											
Delay for temperature alarm	A03	30 min	30 min	30 min	30 min	10 min	10 min	30 min	10 min	10 min	30 min
Delay for temperature alarm after defrost	A12	60 min	60 min	60 min	60 min	35 min	35 min	60 min	45 min	45 min	90 min
High alarm limit	A13	13.0°C	-11.0°C	-11.0°C	-11.0°C	-15.0°C	-15.0°C	10.0°C	2.0°C	5.0°C	8.0°C
Low alarm limit	A14	-8.0°C	-32.0°C	-32.0°C	-35.0°C	-50.0°C	-50.0°C	-10.0°C	-50.0°C	-50.0°C	-30.0°C
Definition of alarm sensor	A33	1	1	1	1	2	1	1	1	1	1
Signal for alarm thermostat. S4% (100%=S4, 0%=S3)	A36	0	0	0	100%	0	100%	0	100%	100%	100%
High alarm limit for S3	A56	13.0°C	-11.0°C	-11.0°C	-11.0°C	-16.0°C	-15.0°C	10.0°C	50.0°C	50.0°C	8.0°C
Low alarm limit for S3	A57	-8.0°C	-32.0°C	-32.0°C	-35.0°C	-50.0°C	-50.0°C	-10.0°C	-50.0°C	-50.0°C	-30.0°C
Compressor											
Reversed relay function for Compressor relay 1 (NC-function)	c30	0	0	0	0	0	0	0	1	1	0
Defrost											
Defrost stop temperature	d02	5.0°C	5.0°C	5.0°C	5.0°C	5.0°C	15.0°C	7.0°C	10.0°C	10.0°C	6.0°C
Interval between defrost starts	d03	12 hours	12 hours	48 hours	12 hours	24 hours	24 hours	6 hours	4 hours	4 hours	8 hours
Max. defrost duration	d04	45 min	45 min	45 min	45 min	60 min	45 min	40 min	35 min	35 min	45 min
Drip off time	d06	0 min	2 min	2 min	2 min	10 min	10 min	0 min	0 min	0 min	0 min
Delay for fan start after defrost	d07	0 min	3 min	0 min	3 min	5 min	5 min	0 min	0 min	0 min	0 min
Fan cutin during defrost	d09	Yes	No	Yes	No	No	No	Yes	Yes	Yes	Yes
Defrost sensor	d10	0	0	0	0	0	0	0	S4	S4	0
Miscellaneous											
Delay of output signal after start-up	o01	5 s	5 s	5 s	5 s	5 s	5 s	5 s	0	0	5s
Used sensor type (Pt /PTC/NTC)	o06	NTC	NTC	NTC	NTC	NTC	NTC	NTC	NTC	NTC	Pt
Display step = 0.5 (normal 0.1 at Pt sensor)	o15	Yes	Yes	Yes	Yes	Yes	Yes	Yes	No	No	No
Max hold time after coordinated defrost	o16	20 min	20 min	25 min	25 min	15 min	15 min	20 min	30 min	30 min	20 min
Select signal for display view. S4% (100%=S4, 0%=S3)	o17	0	0	0	100%	0	100%	0	0	0	100%
Input signal on DI2. Function:	o37	12	12	12	12	12	12	12	12	12	0
Rail heat during day operation	o41	100%	100%	100%	100%	100%	100%	100%	0	0	100%
Rail heat during night operation	o42	100%	100%	100%	100%	100%	100%	100%	0	0	100%

The buttons

Set menu

1. Push the upper button until a parameter r01 is shown
2. Push the upper or the lower button and find that parameter you want to change
3. Push the middle button until the parameter value is shown
4. Push the upper or the lower button and select the new value
5. Push the middle button again to enter the value.

Cutout alarm relay / receipt alarm/see alarm code

- Push short the upper button

Set temperature

1. Push the middle button until the temperature value is shown
2. Push the upper or the lower button and select the new value
3. Push the middle button to select the setting.

Reading the temperature at defrost sensor

- Push briefly the lower button

Manuel start or stop of a defrost

- Push the lower button for four seconds.

LED

Light emitting diode

 = refrigeration

 = defrost

 = fan running

Flashes fast at alarm

Deutsch

SW = 1.5x

Parameter	Code	EL-Diagramm-nummer (Seite 1)			Min.-Wert	Max.-Wert	Werks-einstellung	Aktuelle Einstellung
		1	2	3				
Funktion								
Normal Betrieb								
Temperatur (Sollwert)	---				-50.0°C	50.0°C	2.0°C	
Thermostat								
Differenz	*** r01				0.0 K	20.0 K	2.0 K	
Max. Begrenzung des Sollwert-einstellung	*** r02				-49.0°C	50°C	50.0°C	
Min. Begrenzung des Sollwert-einstellung	*** r03				-50.0°C	49.0°C	-50.0°C	
Justierung der Temperaturanzeige	r04				-20.0 K	20.0 K	0.0 K	
Temperatur Einheit (°C/°F)	r05				°C	°F	°C	
Korrektur des Signals vom S4	r09				-10.0 K	+10.0 K	0.0 K	
Korrektur des Signals vom S3	r10				-10.0 K	+10.0 K	0.0 K	
Manuel Service, Regelung stoppen, Regelung starten (-1, 0, 1)	r12				-1	1	0	
Sollwertverschiebung während Nacht betrieb	r13				-10.0 K	10.0 K	0.0 K	
Definition und evtl. gewichtung der Thermostatfühler - S4%. (100%=S4, 0%=S3)	r15				0%	100%	100%	
Aktivierung der Sollwertverschiebung r40	r39				OFF	ON	OFF	
Wert der Sollwertverschiebung (durch r39 oder DI aktivieren)	r40				-50.0 K	50.0 K	0.0 K	
Definition und evtl. Gewichtung der Thermostatfühler, wenn Nachttrollos geschlossen sind. (100%=S4, 0%=S3)	r61				0%	100%	100%	
Temperatur unterschied für Nachtdeckung (0 K = keine Erkennung)	r75				0 K	20 K	0 K	
Alarm								
Verzögerung des Temperaturalarms	A03				0 min	240 min	30 min	
Verzögerung des Türalarms	*** A04				0 min	240 min	60 min	
Verzögerung auf Temperaturalarm nach Abtauerung	A12				0 min	240 min	90 min	
Alarmgrenze hoch	*** A13				-50.0°C	50.0°C	8.0°C	
Alarmgrenze tief	*** A14				-50.0°C	50.0°C	-30.0°C	
Alarmverzögerung DI1	A27				0 min	240 min	30 min	
Alarmverzögerung DI2	A28				0 min	240 min	30 min	
Festlegen eines Alarmfühlers 1: Kombination aus S3 und S4 (A36, A13 und A14 müssen eingestellt sein) 2: Separate Werte für S3 und S4 (A13, A14, A56 und A57 müssen eingestellt sein)	A33				1	2	1	
Signal für Alarmthermostat. S4% (100%=S4, 0%=S3)	A36				0%	100%	100%	
Hoch Alarm grenze für S3	A56				-50.0°C	50.0°C	8.0°C	
Nieder Alarm grenze für S3	A57				-50.0°C	50.0°C	-30.0°C	
Verdichter								
Min. ON-Zeit	c01				0 min	30 min	0 min	
Min. OFF-Zeit	c02				0 min	30 min	0 min	
Verdichterrelais 1 muss entgegengesetzt schalten (NC-Funktion)	c30				0	1	0	
					OFF	ON	OFF	
Abtauerung								
Abtaumethode (keine/EL/GAS/BRINE)	d01				no	bri	EL	
Abtau-Stoptemperatur	d02				0.0°C	25.0°C	6.0°C	
Interval zwischen Abtaustarten	d03				0 hours	240 hours	8 hours	
Max. Abtaudauer	d04				0 min	180 min	45 min	
Zeitverzögerung an der Abtaueinschaltung bei Aufstart	d05				0 min	240 min	0 min	
Abtropfzeit	d06				0 min	60 min	0 min	
Verzögerung des Lüfterstarts nach der Abtauerung	d07				0 min	60 min	0 min	
Lüfter-Starttemperatur	d08				-50.0°C	0.0°C	-50.0°C	
Lüfter eingeschaltet während der Abtauerung 0: Gestoppt. 1: Läuft. 2: Läuft während Pump Down und Abtauerung	d09				0	2	1	
Abtaufühler (0=Zeit, 1=S5, 2=S4)	d10				0	2	0	
Pump down verzögerung	d16				0 min	60 min	0 min	
Max. Laufzeit der Kühlung zwischen zwei Abtauerungen	d18				0 hours	48 hours	0 hours	
Bedarfsgesteuerte Abtauerung - die S5 Temperatur erlaubt variation bei Eis-aufbauung. Centralanlagen, wähle 20 K (=off)	d19				0.0 K	20.0 k	20.0 K	
Mindestabtaudauer	d24				0 min	180 min	0 min	
Lüfter								
Lüfterstop bei abgeschaltetem Verdichter	F01				no	yes	no	
Verzögerung der Lüfterabschaltung	F02				0 min	30 min	0 min	
Lüfterstop Temperatur (S5)	F04				-50.0°C	50.0°C	50.0°C	
Echtzeituhr								
Sechs Startzeitpunkte für Abtauerung. Einstellung in Stunden 0=OFF	t01-t06				0 hours	23 hours	0 hours	
Sechs Startzeitpunkte für Abtauerung. Einstellung in Minuten 0=OFF	t11-t16				0 min	59 min	0 min	
Uhr - Einstellung Stunden	*** t07				0 hours	23 hours	0 hours	
Uhr - Einstellung Minuten	*** t08				0 min	59 min	0 min	
Uhr - Einstellung des Datums	*** t45				1	31	1	
Uhr - Einstellung des Monats	*** t46				1	12	1	
Uhr - Einstellung des Jahrs	*** t47				0	99	0	

Einstellen:

- 1 Parameter r12 öffnen und Regelung stoppen**
- 2 Elektrische Verbindung von den Zeichnungen auf Seite 1 auswählen**
- 3 Parameter o61 öffnen und die Nummer der Elektrischen Verbindung hier einstellen**
- 4 Nummer der gewünschten Voreinstellung aus der Tabelle Seite 10 auswählen**
- 5 Parameter o62 öffnen und die Nummer für den Datensatz der Voreinstellung eingeben. Mit mittlerer Taste bestätigen um die Einstellungen ins Menü kopieren.**
- 6 Regelung wird jetzt gestartet (r12 wurde in Punkt 5 auf 1 eingestellt)**
- 7 Die Übersicht über Werkseinstellungen durchsehen. — Die notwendigen Änderungen in den jeweiligen Parametern vornehmen.**
- 8 Bei Netzwerken: Die Adresse in o03 einstellen und anschließend mit der Einstellung o04 an das Gateway/die Systemeinheit senden.**

Diverses							
Verzögerung des Ausgangssignales nach dem Anlauf		o01			0 s	600 s	5 s
Eingangssignal am DI1. Funktion: (0=wird nicht verwendet. 1=Status am DI1. 2=Türfunktion mit Alarm bei offen. 3=Türalarm bei offen. 4=Abtaustart (Puls-Signal). 5=Ext.Hauptschalter. 6=Nachtbetrieb. 7=Sollwert wechseln (r40 wird aktiviert). 8=Alarmfunktion bei geschlossen. 9=Alarmfunktion bei offen. 10=Möbelreinigung (Puls-Signal). 11=Zwangskühlung. 12=S5B		o02			1	12	0
Netzwerkadresse		o03			0	240	0
On/Off Wechselschalter (Service Pin Mitteilung) ACHTUNG! o61 muss vor o04 eingestellt werden		o04			OFF	ON	OFF
Zugangskode 1 (sämtliche Einstellungen)		o05			0	100	0
Angewandter Fühlertyp (Pt /PTC/NTC)		o06			Pt	ntc	Pt
Display step = 0.5 (normal 0.1 bei Pt Fühler)		o15			no	yes	no
Max Hold time nach koordinierte Abtaung		o16			0 min	60 min	20 min
Signal für Displayanzeige wählen. S4% (100%=S4, 0%=S3)		o17			0%	100%	100%
Eingangssignal am DI2. Funktion: (0=wird nicht verwendet.1=Status am DI2. 2=Türfunktion mit Alarm bei offen. 3=Türalarm bei offen. 4=Abtaustart (Puls-Signal). 5=Externer Hauptschalter. 6=Nachtbetrieb 7=Sollwert wechseln (r40 wird aktiviert). 8=Alarmfunktion bei geschlossen. 9=Alarmfunktion bei offen. 10=Möbelreinigung (Puls-Signal). 11=Zwangskühlung. 12=koordinierte Abtaung)		o37			0	12	0
Konfiguration von Lichtfunktion (Relais 4) 1=ON während Tagesbetrieb. 2=ON / OFF via Datenkommunikation. 3=ON folgt die DI-funktion, wenn DI für Türfunktion oder Türalarm gewählt ist		o38			1	3	1
Aktivierung von Lichtrelais (Nur wenn o38=2)		o39			OFF	ON	OFF
Rahmen Heizung On-Zeit während Tagesbetrieb		o41			0%	100%	100%
Rahmenheizung On-Zeit während Nachtbetrieb		o42			0%	100%	100%
Rahmenheizung Periodenzeit (On Zeit + Off Zeit)		o43			6 min	60 min	10 min
Möbelreinigung. 0= Keine Reinigung. 1= Nur Lüfter. 2=Alle Ausgänge OFF.	***	o46			0	2	0
Wahl des EL-Diagramms. Siehe Übersicht Seite 1	*	o61	1	2	3	1	3
Aktivierung der Voreinstellungen. Siehe Tabelle Seite 10.	*	o62				0	10
Zugangskode 2 (Teilweiser Zugang)	***	o64				0	100
Gegenwärtige Einstellungen des Reglers zu einen Programmierungs Key speichern. Wähle selber eine Nummer.		o65				0	25
Ein Satz von Einstellungen von den Programmierungs Keys laden (früher mit der Funktion o65 gespeichert)		o66				0	25
Die Werkseinstellungen des Reglers mit den jetzigen Einstellungen überschreiben.		o67				OFF	On
Service							
Statuskodes		S0-S33					
Temperatur gemessen mit S5 Fühler	***	u09					
Status am DI1 Eingang. 1=geschlossen		u10					
Temperatur gemessen mit S3 Fühler	***	u12					
Status Nachtbetrieb (on oder off) 1=geschlossen	***	u13					
Temperatur gemessen mit S4 Fühler	***	u16					
Thermostattemperatur		u17					
Den augenblicklichen Regelsollwert anzeigen		u28					
Status am DI2 Ausgang. 1=geschlossen		u37					
Temperaturanzeige auf dem Display		u56					
Gemessene Temperatur für den Alarmthermostaten		u57					
Status am Relais für Kühlung	**	u58					
Status am Relais für Lüfter	**	u59					
Status am Relais für Abtaung	**	u60					
Status am Relais für Rahmenheizung	**	u61					
Status am Relais für Alarm	**	u62					
Status am Relais für Licht	**	u63					
Temperatur gemessen mit S5B Fühler	***	u75					
Status der Nachtdeckungserkennung (Ein = Nachtdeckung wurde erkannt)		U08					

*) Lässt sich nur bei gestoppter Regelung einstellen (r12=0)

**) Lässt sich manuell steuern, jedoch nur bei r12= -1

***) Mit Zugangskode 2 wird der Zugang zu diesen Menüs begrenzt

Fehlercodeanzeige	
E 1	Fehler am Regler
E 6	Batterie austauschen + Uhr kontrollieren
E 25	S3 Fühler Fehler
E 26	S4 Fühler Fehler
E 27	S5 Fühler Fehler
E 37	S5B Fühler Fehler
Alarm - Fehlercodeanzeige	
A 1	Hoch-temperaturalarm
A 2	Tief-temperaturalarm
A 4	Tür-alarm
A 5	Max. Hold time
A 8	Hoch Temp. Alarm S3
A 9	Nieder Temp. Alarm S3
A 15	DI 1 Alarm
A 16	DI 2 Alarm
A 45	Standby mode
A 59	Möbelreinigung
A 81	S3 und S4 Fühler vertauscht?
Anzeige des Statuscodes	
S0	Es wird geregelt
S 1	Wartet auf beendigung der koordinierten Abtaung
S 2	ON-Zeit Verdichter
S 3	OFF-Zeit Verdichter
S 4	Abtropfzeit
S 10	Kühlung von dem Hauptschalter gestoppt
S 11	Kühlung vom Thermostat gestoppt
S 14	Abtausequenz. Abtaung
S 15	Abtausequenz. Lüfter-Verzögerung
S 17	Tür offen (DI Eingang offen)
S 20	Notkühlung
S 25	Manuelle Regelung der Ausgänge
S 29	Möbelreinigung
S 30	Zwangskühlung
S 32	Verzögerung der Ausgänge bei Anlauf
non	Abtautemperatur kann nicht angezeigt werden. Es wird zeitabhängig gestoppt.
-d-	Abtaung ist in Gang
PS	Passwort ist erforderlich.

Werkseinstellung

Die Rückkehr zur Werkseinstellung lässt sich wie folgt vornehmen:

- Die Spannungszufuhr zum Regler unterbrechen.

- Die obere und die untere Taste gleichzeitig gedrückt halten und gleichzeitig die Spannungszufuhr wieder herstellen.

Satz von voreinstellungen (o62)=		1	2	3	4	5	6	7	8	9	10
Funktion / Kode											
Normal betrieb											
Temperatur (Sollwert)	---	-8.0°C	-32.0°C	-30.0°C	-32.0°C	-28.0°C	-28.0°C	-2.0°C	-1.5°C	0.5°C	-2.0°C
Thermostat											
Differenz	r01	4.0 K	4.0 K	1.0 K	4.0 K	1.0 K	1.0 K	1.0 K	1.0 K	1.0 K	2.0 K
Einstellung der max. sollwertbegrenzung	r02	-5.0°C	-28.0°C	-28.0°C	-28.0°C	-25.0°C	-25.0°C	5.0°C	6.0°C	4.0°C	50.0°C
Einstellung der Min. sollwertbegrenzung	r03	-10.0°C	-34.0°C	-34.0°C	-34.0°C	-50.0°C	-50.0°C	-10.0°C	-2.0°C	-1.0°C	-50.0°C
Manueller Start-/stop der Regelung (-1, 0, 1)	r12	1	1	1	1	1	1	1	1	1	0
Nachtanhebungswert	r13	0	0	0	0	0	0	0	3 K	3 K	0
Wert der Sollwertverschiebung	r40	0	0	0	0	6 K	0	0	-1.5 K	0.5 K	0
Wahl des Thermostat fühlens S4% während Nachtbetrieb mit Nacht Rollos	r61	0	0	0	100%	0	0	0	0	0	100%
Temperatur Sollwert für Nacht Rollos	r75	0	0	0	0	0	0	0	3 K	3 K	0
Alarm											
Alarmverzögerung für Temperatur	A03	30 min	30 min	30 min	30 min	10 min	10 min	30 min	10 min	10 min	30 min
Verzögerung bei Kühlung (lange Alarmverzögerung)	A12	60 min	60 min	60 min	60 min	35 min	35 min	60 min	45 min	45 min	90 min
Obere Alarm grenze	A13	13.0°C	-11.0°C	-11.0°C	-11.0°C	-15.0°C	-15.0°C	10.0°C	2.0°C	5.0°C	8.0°C
Untere Alarm grenze	A14	-8.0°C	-32.0°C	-32.0°C	-35.0°C	-50.0°C	-50.0°C	-10.0°C	-50.0°C	-50.0°C	-30.0°C
Definition des Alarmfühlers	A33	1	1	1	1	2	1	1	1	1	1
Signal zum Alarmthermostat S4% (100%=S4, 0%=S3)	A36	0	0	0	100%	0	100%	0	100%	100%	100%
Hoch Alarm grenze für S3	A56	13.0°C	-11.0°C	-11.0°C	-11.0°C	-16.0°C	-15.0°C	10.0°C	50.0°C	50.0°C	8.0°C
Nieder Alarm Grenze für S3	A57	-8.0°C	-32.0°C	-32.0°C	-35.0°C	-50.0°C	-50.0°C	-10.0°C	-50.0°C	-50.0°C	-30.0°C
Verdichter											
Umgekehrte Relaisfunktion für Verdichter Relais 1 (DO1) (NC-funktion)	c30	0	0	0	0	0	0	0	1	1	0
Abtauung											
Abtau-Stoppptemperatur	d02	5.0°C	5.0°C	5.0°C	5.0°C	5.0°C	15.0°C	7.0°C	10.0°C	10.0°C	6.0°C
Intervall zwischen Abtaustarts	d03	12 hours	12 hours	48 hours	12 hours	24 hours	24 hours	6 hours	4 hours	4 hours	8 hours
Max. Abtauungsdauer	d04	45 min	45 min	45 min	45 min	60 min	45 min	40 min	35 min	35 min	45 min
Abtropfzeit	d06	0 min	2 min	2 min	2 min	10 min	10 min	0 min	0 min	0 min	0 min
Verzögerung des Lüfterstarts nach der Abtauung	d07	0 min	3 min	0 min	3 min	5 min	5 min	0 min	0 min	0 min	0 min
Lüfter eingeschaltet während der Abtauung	d09	Yes	No	Yes	No	No	No	Yes	Yes	Yes	Yes
Abtaufühler	d10	0	0	0	0	0	0	0	S4	S4	0
Diverses											
Verzögerung der Ausgangssignale nach dem Anlauf	o01	5 s	5 s	5 s	5 s	5 s	5 s	5 s	0	0	5s
Fühlertyp (Pt /PTC/NTC)	o06	NTC	NTC	NTC	NTC	NTC	NTC	NTC	NTC	NTC	Pt
Displaystufen = 0.5 (normal 0.1 at Pt sensor)	o15	Yes	Yes	Yes	Yes	Yes	Yes	Yes	No	No	No
Max. Standby Zeit nach koordinierter Abtauung	o16	20 min	20 min	25 min	25 min	15 min	15 min	20 min	30 min	30 min	20 min
Wahl des Signals zur Displayanzeige - S4% (100%=S4, 0%=S3)	o17	0	0	0	100%	0	100%	0	0	0	100%
Digitale Eingangssignal- DI2	o37	12	12	12	12	12	12	12	12	12	0
Rahmenheizung bei Tagesbetrieb	o41	100%	100%	100%	100%	100%	100%	100%	0	0	100%
Rahmenheizung bei Nachtbetrieb	o42	100%	100%	100%	100%	100%	100%	100%	0	0	100%

Tasten

Menü einstellen

1. Die obere Taste betätigen, bis ein Parameter zur Anzeige gelangt
2. Die obere oder die untere Taste betätigen um zum gewünschten Parameter zu gelangen
3. Die mittlere Taste betätigen, bis der Wert des Parameters zur Anzeige kommt
4. Die obere oder die untere Taste betätigen um einen neuen Wert zu finden
5. Erneut die mittlere Taste betätigen um den Wert festzuhalten.

Alarmrelais ausschalten/ siehe Alarmkode

- Die oberste Taste kurz betätigen

Temperatur einstellen

1. Die mittlere Taste betätigen, bis der Temperaturwert zur Anzeige gelangt
2. Die obere oder die untere Taste betätigen um einen neuen Wert zu finden
3. Die mittlere Taste betätigen um den Einstellvorgang abzuschließen.

Ablesen der Temperatur am Abtaufühler



- Die untere Taste kurz betätigen

Manueller start oder stop einer Abtauung

- Die untere Taste für etwa 4 Sekunden betätigen.

LED

Leuchtdiode

-  = Kühlung
-  = Abtauung
-  = Lüfter läuft

Blinkt schnell bei Alarm

Français

SW = 1.5x

Paramètres	Codes	Numéro schéma électrique			Valeur mini	Valeur maxi	Réglage usine	Réglage actuel
		1	2	3				
Fonction								
Fonctionnement normal								
Température (point de consigne)	---				-50.0°C	50.0°C	2.0°C	
Thermostat								
Différentiel	***	r01			0.0 K	20.0 K	2.0 K	
Limite max. de température de réglage	***	r02			-49.0°C	50.0°C	50.0°C	
Limite min. de température de réglage	***	r03			-50.0°C	49.0°C	-50.0°C	
Réglage de l'affichage de température		r04			-20.0 K	20.0 K	0.0 K	
Unités de température (°C/°F)		r05			°C	°F	°C	
Correction du signal en provenance de S4		r09			-10.0 K	10.0 K	0.0 K	
Correction du signal en provenance de S3		r10			-10.0 K	10.0 K	0.0 K	
Service manuel, Arrêt régulation, marche régulation (-1, 0, 1)		r12			-1	1	0	
Décalage de référence en régime de nuit		r13			-10.0 K	10.0 K	0.0 K	
Définition et pondération éventuelle des sondes thermostatique. - S4% (100%=S4, 0%=S3)		r15			0%	100%	100%	
Actionnement d'une déviation de référence r40		r39			OFF	ON	OFF	
Valeur de la déviation de référence (activation par r39 ou DI)		r40			-50.0 K	50.0 K	0.0 K	
La sonde thermostatique S4% peut être sélectionnée en fonctionnement nocturne avec rideaux de nuit.		r61			0%	100%	100%	
La différence de température pour le régime de nuit (0 K = non détecté)		r75			0 K	20 K	0 K	
Alarme								
Temporisation de l'alarme température		A03			0 min	240 min	30 min	
Temporisation de l'alarme porte	***	A04			0 min	240 min	60 min	
Temporisation de l'alarme température après le dégivrage		A12			0 min	240 min	90 min	
Limites d'alarme haute	***	A13			-50.0°C	50.0°C	8.0°C	
Limites d'alarme basse	***	A14			-50.0°C	50.0°C	-30.0°C	
Temporisation de l'alarme DI1		A27			0 min	240 min	30 min	
Temporisation de l'alarme DI2		A28			0 min	240 min	30 min	
Définition de la sonde d'alarme 1: Combinaison de S3 et S4 (A36, A13 et A14 doivent être définis) 2: Valeurs séparées pour S3 et S4 (A13, A14, A56 et A57 doivent être définis)		A33			1	2	1	
Signal vers le thermostat d'alarme. S4% (100%=S4, 0%=S3)		A36			0%	100%	100%	
Limites d'alarme haute S3		A56			-50.0°C	50.0°C	8.0°C	
Limites d'alarme basse S3		A57			-50.0°C	50.0°C	-30.0°C	
Compresseur								
Temps de marche min.		c01			0 min	30 min	0 min	
Intervalle entre deux démarrages		c02			0 min	30 min	0 min	
Le relais de compresseur 1 doit agir inversement. (fonction NF)		c30			0 OFF	1 ON	0 OFF	
Dégivrage								
Méthode (non/EL/GAS/BRINE)		d01			no	bri	EL	
Température d'arrêt du dégivrage		d02			0.0°C	25.0°C	6.0°C	
Intervalle entre démarrages du dégivrage		d03			0 hours	240 hours	8 hours	
durée max. du dégivrage		d04			0 min	180 min	45 min	
Retard du dégivrage à la mise sous-tension		d05			0 min	240 min	0 min	
Temps d'égouttement		d06			0 min	60 min	0 min	
Temporisation de démarrage du ventilateur après le dégivrage		d07			0 min	60 min	0 min	
Température de démarrage du ventilateur		d08			-50.0°C	0.0°C	-50.0°C	
Ventilateur enclenché pendant le dégivrage 0: Arrêté, 1: Actif, 2: En marche pendant l'évacuation et le dégivrage.		d09			0	2	1	
Test de la sonde de dégivrage (0=temps, 1=S5, 2=S4)		d10			0	2	0	
Temporisation de la mise au vide		d16			0 min	60 min	0 min	
Temps de refroidissement total maxi entre deux dégivrages		d18			0 hours	48 hours	0 hours	
Dégivrage sur demande – variation admissible de la température S5 en cas de formation de givre Pour les installations centralisées, on choisit 20 K (= OFF)		d19			0.0 K	20.0 k	20.0 K	
Minimum defrost time		d24			0 min	180 min	0 min	
Ventilateur								
Arrêt du ventilateur à compresseur déclenché		F01			no	yes	no	
Temporisation de l'arrêt du ventilateur		F02			0 min	30 min	0 min	
Arrêt de ventilateur température (S5)		F04			-50.0°C	50.0°C	50.0°C	
Horloge en temps réel								
Heures de démarrage des six dégivrages Réglage heures. 0=OFF		t01-t06			0 hours	23 hours	0 hours	
Heures de démarrage des six dégivrages Réglage heures. 0=OFF		t11-t16			0 min	59 min	0 min	
Horloge - Réglage heures	***	t07			0 hours	23 hours	0 hours	
Horloge - Réglage minutes	***	t08			0 min	59 min	0 min	

Réglages:

1 Allez au paramètre r12 et arrêtez le régulateur

2 Choisissez la connexion électrique selon les plans page 1

3 Allez au paramètre o61 pour y inscrire le numéro de la connexion

4 Choisissez ensuite un jeu de pré-réglages de la table page 13

5 Allez au paramètre o62 pour y inscrire le numéro du jeu de pré-réglages Les quelques réglages choisis sont alors transférés au menu

6 La régulation démarre (r12 peut être réglé sur 1 au point 5)

7 Parcourez le sommaire des réglages départ usine. Procédez aux éventuelles modifications nécessaires.

8 En cas de réseau : Inscrivez l'adresse en o03 et envoyez-la ensuite à l'unité passerelle/système avec le réglage o04.

Horloge - Horloge - Réglage date	***	t45			1	31	1	
Horloge - Horloge - Réglage mois	***	t46			1	12	1	
Horloge - Horloge - Réglage année	***	t47			0	99	0	
Divers								
Temporisation des signaux de sortie lors de la mise en route		o01			0 s	600 s	5 s	
Signaux d'entrée DI1. Fonction: (0= non utilisée, 1=état de DI1. 2=fonction porte avec alarme d'ouverture 3=alarme porte ouverte. 4=début de dégivrage (impulsion de signal). 5=interrupteur principal externe. 6=régime de nuit. 7=changer de référence (activation r40). 8=fonction d'alarme à enclenchement. 9=fonction d'alarme à déclenchement. 10=nettoyage de meuble (impulsion de signal). 11=Refroidissement forcé. 12=S5B.		o02			0	12	0	
Adresse réseau		o03			0	240	0	
Commutateur On/Off (message broche service) IMPORTANT !! Il faut régler o61 avant o04		o04			OFF	ON	OFF	
Code d'accès 1 (tous les réglages)		o05			0	100	0	
Type de sonde utilisé (Pt /PTC/NTC)		o06			Pt	ntc	Pt	
Cran d'affichage = 0.5 (norme 0,1/capteur Pt)		o15			no	yes	no	
Temps d'attente max. après dégivrage coordonné		o16			0 min	60 min	20	
Choix de signal pour l'afficheur. S4% (100%=S4, 0%=S3)		o17			0%	100%	100%	
Signaux d'entrée DI2. Fonction: (0= non utilisée, 1=état de DI2. 2=fonction porte avec alarme d'ouverture. 3=alarme porte ouverte. 4=début de dégivrage (poussoir). 5=interrupteur principal externe. 6=régime de nuit. 7=changer de référence (activation r40). 8=fonction d'alarme à enclenchement. 9=fonction d'alarme à déclenchement. 10=nettoyage de meuble (poussoir). 11=Refroidissement forcé. 12=dégivrage coordonné)		o37			0	12	0	
Configuration de la fonction d'éclairage (relais 4)		o38			1	3	1	
1=ON en régime de jour. 2=ON/OFF par la transmission de données. 3=ON suivant la fonction DI, si DI a été choisie pour la fonction ou l'alarme porte								
Actionnement du relais d'éclairage (seulement si o38=2)		o39			OFF	ON	OFF	
Rails antibuée, temps ON en régime de jour		o41			0%	100%	100%	
Rails antibuée, temps ON en régime de nuit		o42			0%	100%	100%	
Rails antibuée, période (temps ON + temps OFF)		o43			6 min	60 min	10 min	
Nettoyage de meuble. 0=aucun nettoyage 1=ventilateurs seulement. 2=toutes les sorties sont OFF	***	o46			0	2	0	
Choix de schéma électrique. Reportez-vous à la table récapitulative page 1.	*	o61	1	2	3	1	3	1
Transfert d'un ensemble de pré-réglages. Voir l'aperçu en page 13.	*	o62			0	10	0	
Code d'accès 2 (accès partiel)	***	o64			0	100	0	
Conservez les réglages actuels de l'appareil comme clé de programmation. Choisissez votre propre numéro.		o65			0	25	0	
Appel d'un jeu de réglages de la clé de programmation. (sauvée auparavant via la fonction o65)		o66			0	25	0	
Surchargez les réglages usine avec les réglages actuels du régulateur		o67			OFF	On	OFF	
Entretien								
Les codes d'état		S0-S33						
Température relevée par la sonde S5	***	u09						
État de l'entrée DI1. On/1=enclenchée		u10						
Température relevée par la sonde S3	***	u12						
État du régime de nuit (tout ou rien) 1=enclenché	***	u13						
Température relevée par la sonde S4	***	u16						
Température du thermostat		u17						
Affichage de la référence de régulation actuelle		u28						
État de la sortie DI2. On/1=enclenchée		u37						
Température visualisée par l'afficheur		u56						
Température captée pour le thermostat d'alarme		u57						
État du relais de refroidissement	**	u58						
État du relais du ventilateur	**	u59						
État du relais de dégivrage	**	u60						
État du relais des rails antibuée	**	u61						
État du relais d'alarme	**	u62						
État du relais d'éclairage	**	u63						
Température relevée par la sonde S5B	***	u75						
État de la détection de régime de nuit (On = les rideaux de nuit ont été détectés)		U08						

Affichage de codes de défauts	
E 1	Défaut de régulateur
E 6	Changer la pile + vérifier heure
E 25	Erreur de sonde S3
E 26	Erreur de sonde S4
E 27	Erreur de sonde S5
E 37	Erreur de sonde S5B
Affichage code alarme	
A 1	Alarme température haute
A 2	Alarme température basse
A 4	Alarme porte
A 5	Max. Hold time
A 8	Alarme température haute pour S3
A 9	Alarme température basse pour S3
A 15	DI 1 alarme
A 16	DI 2 alarme
A 45	Standby mode
A 59	Nettoyage de meuble
A 81	Inversion des sondes S3 et S4 ?
Affichage des états	
S0	Régulation en cours
S 1	Attend la fin du dégivrage coordonné
S 2	Temps ON du compresseur
S 3	Temps OFF du compresseur
S 4	Égouttage
S 10	Le refroidissement a été arrêté au "Main switch" (interrupteur principal)
S 11	Le refroidissement a été arrêté au thermostat
S 14	Séquence du dégivrage. Dégivrage en cours
S 15	Séquence du dégivrage. Temporisation du ou des ventilateurs
S 17	Porte ouverte (Entrée DI ouverte)
S 20	Refroidissement de secours
S 25	Régulation manuelle les sorties
S 29	Nettoyage de meuble
S 30	Refroidissement forcé
S 32	Temporisation des sorties à la mise en route
non	Température de dégivrage pas accessible Arrêt sur temps
-d-	Dégivrage en cours
PS	Mot de passe imposé

Réglage départ usine

Pour retrouver éventuellement les valeurs réglées en usine, procéder ainsi :

- Couper la tension d'alimentation du régulateur.

- Maintenir les boutons supérieur et inférieur enfoncés en remettant le régulateur sous tension.

*) Ce réglage n'est possible que si la régulation est arrêtée (r12=0)

**) La commande manuelle est possible mais à condition que r12=-1

***) Le code d'accès 2 permet de limiter les accès à ces menus

Transfert d'un ensemble de pré-réglages. 062 =	1	2	3	4	5	6	7	8	9	10	
Fonction											
Fonctionnement normal											
Température (point de consigne)	---	-8.0°C	-32.0°C	-30.0°C	-32.0°C	-28.0°C	-28.0°C	-2.0°C	-1.5°C	0.5°C	-2.0°C
Thermostat											
Différentiel	r01	4.0 K	4.0 K	1.0 K	4.0 K	1.0 K	1.0 K	1.0 K	1.0 K	1.0 K	2.0 K
Limite max. de température de réglage	r02	-5.0°C	-28.0°C	-28.0°C	-28.0°C	-25.0°C	-25.0°C	5.0°C	6.0°C	4.0°C	50.0°C
Limite min. de température de réglage	r03	-10.0°C	-34.0°C	-34.0°C	-34.0°C	-50.0°C	-50.0°C	-10.0°C	-2.0°C	-1.0°C	-50.0°C
Service manuel, Arrêt régulation, marche régulation	r12	1	1	1	1	1	1	1	1	1	0
Valeur de régime de nuit	r13	0	0	0	0	0	0	0	3 K	3 K	0
Valeur du décalage de référence	r40	0	0	0	0	6 K	0	0	-1.5 K	0.5 K	0
Choix de sonde de thermostat 54% pour régime de nuit avec rideau de nuit	r61	0	0	0	100%	0	0	0	0	0	100%
Différence de température avec les rideaux de nuit	r75	0	0	0	0	0	0	0	3 K	3 K	0
Alarme											
Temporisation de l'alarme température	A03	30 min	30 min	30 min	30 min	10 min	10 min	30 min	10 min	10 min	30 min
Temporisation de l'alarme température après le dégivrage	A12	60 min	60 min	60 min	60 min	35 min	35 min	60 min	45 min	45 min	90 min
Limites d'alarme haute	A13	13.0°C	-11.0°C	-11.0°C	-11.0°C	-15.0°C	-15.0°C	10.0°C	2.0°C	5.0°C	8.0°C
Limites d'alarme basse	A14	-8.0°C	-32.0°C	-32.0°C	-35.0°C	-50.0°C	-50.0°C	-10.0°C	-50.0°C	-50.0°C	-30.0°C
Définition de la sonde d'alarme 1: Combinaison de S3 et S4 (A36, A13 et A14 doivent être définis) 2: Valeurs séparées pour S3 et S4 (A13, A14, A56 et A57 doivent être définis)	A33	1	1	1	1	2	1	1	1	1	1
Signal vers le thermostat d'alarme. 54% (100%=S4, 0%=S3)	A36	0	0	0	100%	0	100%	0	100%	100%	100%
Limites d'alarme haute S3	A56	13.0°C	-11.0°C	-11.0°C	-11.0°C	-16.0°C	-15.0°C	10.0°C	50.0°C	50.0°C	8.0°C
Limites d'alarme basse S3	A57	-8.0°C	-32.0°C	-32.0°C	-35.0°C	-50.0°C	-50.0°C	-10.0°C	-50.0°C	-50.0°C	-30.0°C
Compresseur											
Fonction de relais inversée pour DO1 (NC-fonction)	c30	0	0	0	0	0	0	0	1	1	0
Dégivrage											
Température d'arrêt du dégivrage	d02	5.0°C	5.0°C	5.0°C	5.0°C	5.0°C	15.0°C	7.0°C	10.0°C	10.0°C	6.0°C
Intervalle entre démarrages du dégivrage	d03	12 hours	12 hours	48 hours	12 hours	24 hours	24 hours	6 hours	4 hours	4 hours	8 hours
Durée max. du dégivrage	d04	45 min	45 min	45 min	45 min	60 min	45 min	40 min	35 min	35 min	45 min
Temps d'égouttement	d06	0 min	2 min	2 min	2 min	10 min	10 min	0 min	0 min	0 min	0 min
Temporisation de démarrage du ventilateur après le dégivrage	d07	0 min	3 min	0 min	3 min	5 min	5 min	0 min	0 min	0 min	0 min
Ventilateur enclenché pendant le dégivrage	d09	Yes	No	Yes	No	No	No	Yes	Yes	Yes	Yes
Test de la sonde de dégivrage (0=temps, 1=S5, 2=S4)	d10	0	0	0	0	0	0	0	S4	S4	0
Miscellaneous											
Retard des signaux de sortie lors du démarrage	o01	5 s	5 s	5 s	5 s	5 s	5 s	5 s	0	0	5s
Type de sonde utilisé (Pt /PTC/NTC)	o06	NTC	NTC	NTC	NTC	NTC	NTC	NTC	NTC	NTC	Pt
Cran d'affichage = 0.5 (norme 0,1/capteur Pt)	o15	Yes	Yes	Yes	Yes	Yes	Yes	Yes	No	No	No
Temps d'attente max. après dégivrage coordonné	o16	20 min	20 min	25 min	25 min	15 min	15 min	20 min	30 min	30 min	20 min
Choix de signal pour l'afficheur. 54% (100%=S4, 0%=S3)	o17	0	0	0	100%	0	100%	0	0	0	100%
Signaux d'entrée DI2.	o37	12	12	12	12	12	12	12	12	12	0
Rails antibuée en régime de jour	o41	100%	100%	100%	100%	100%	100%	100%	0	0	100%
Rails antibuée en régime de nuit	o42	100%	100%	100%	100%	100%	100%	100%	0	0	100%

Les Boutons

Réglage d'un menu

- Appuyez sur le bouton supérieur jusqu'à apparition d'un paramètre.
- Appuyez sur le bouton supérieur ou inférieur pour trouver le paramètre à régler
- Appuyez sur le bouton médian jusqu'à apparition de la valeur du paramètre
- Appuyez sur le bouton supérieur ou inférieur pour chercher la nouvelle valeur
- Appuyez à nouveau sur le bouton médian pour verrouiller la valeur.

Déclenchement du relais d'alarme ou visualisation du code d'alarme

- Appuyez brièvement sur le bouton supérieur

Réglage de la température

- Appuyez sur le bouton médian jusqu'à apparition de la valeur de température
- Appuyez sur le bouton supérieur ou inférieur pour chercher la nouvelle valeur
- Appuyez sur le bouton médian pour terminer le réglage.

Contrôle de la température de sonde du dégivrage

- Appuyez brièvement sur le bouton inférieur

Marche/arrêt manuel d'un dégivrage

- Appuyez sur le bouton inférieur pendant 4 secondes.

Diodes lumineuses en façade

Diode lumineuse

 = refroidissement

 = dégivrage

 = Ventilateur en marche

Clignotement rapide en cas d'alarme

Parametri	Numero schema EL (pagina 1)			Valore min.	Valore max.	Taratura	Valore corrente
	Codici	1	2				
Funzione							
Funzionam. normale							
Temperatura (setpoint)	---			-50.0°C	50.0°C	2.0°C	
Termostato							
Differenziale	***	r01		0.0 K	20.0K	2.0 K	
Limite max. per l'impostazione del setpoint	***	r02		-49.0°C	50°C	50.0°C	
Limite min. per l'impostazione del setpoint	***	r03		-50.0°C	49.0°C	-50.0°C	
Regolazione dell'indicazione di temperatura		r04		-20.0 K	20.0 K	0.0 K	
Unità di temperatura (°C/°F)		r05		°C	°F	°C	
Correzione del segnale da S4		r09		-10.0 K	+10.0 K	0.0 K	
Correzione del segnale da S3		r10		-10.0 K	+10.0 K	0.0 K	
Servizio manuale, arresto regolazione, avvio regolazione (-1, 0, 1)		r12		-1	1	0	
Scostamento riferimento in funzionamento notturno		r13		-10.0 K	10.0 K	0.0 K	
Definizione e calcolo, se applicato, dei sensori termostato - S4% (100%=S4, 0%=S3)		r15		0%	100%	100%	
Attivazione spostamento riferimento r40		r39		OFF	ON	OFF	
Valore spostamento del riferimento (attivato da r39 o DI)		r40		-50.0 K	50.0 K	0.0 K	
Il sensore termostato S4 può venire selezionato durante il funzionamento notturno con copertura notte.		r61		0%	100%	100%	
Differenza di temperatura per copertura notte (0 °K = non rilevata)		r75		0 K	20 K	0 K	
Allarme							
Ritardo allarme temperatura		A03		0 min	240 min	30 min	
Ritardo allarme sportello	***	A04		0 min	240 min	60 min	
Ritardo allarme temperatura dopo lo sbrinamento.		A12		0 min	240 min	90 min	
Limite allarme per alta tensione	***	A13		-50.0°C	50.0°C	8.0°C	
Limite allarme di bassa tensione	***	A14		-50.0°C	50.0°C	-30.0°C	
Ritardo allarme DI1		A27		0 min	240 min	30 min	
Ritardo allarme DI2		A28		0 min	240 min	30 min	
Definizione del sensore allarme 1: Combinazione di S3 e S4 (è necessario impostare A36, A13 e A14) 2: Valori separati per S3 e S4 (è necessario impostare A13, A14, A56 e A57)		A33		1	2	1	
Segnale per il termostato con allarme. S4% (100%=S4, 0%=S3)		A36		0%	100%	100%	
Limite allarme alto per S3		A56		-50.0°C	50.0°C	8.0°C	
Limite allarme basso per S3		A57		-50.0°C	50.0°C	-30.0°C	
Compressore							
Tempo min. ON		c01		0 min	30 min	0 min	
Tempo min OFF		c02		0 min	30 min	0 min	
Il relè del compressore 1 deve inserirsi e disinserirsi inversamente (funzione NC)		c30		0 OFF	1 ON	0 OFF	
Sbrinamento							
Sistema di sbrinamento (nessuno/elettrico/gas/salamoia)		d01		no	bri	EL	
Temperatura di arresto sbrinamento		d02		0.0°C	25.0°C	6.0°C	
Intervallo tra due avviamenti dello sbrinamento		d03		0 hours	240 hours	8 hours	
Durata max sbrinamento		d04		0 min	180 min	45 min	
Ritardo inserimento dello sbrinamento all'avviamento		d05		0 min	240 min	0 min	
Tempo gocciolamento		d06		0 min	60 min	0 min	
Avviamento ritardato del ventilatore dopo lo sbrinamento		d07		0 min	60 min	0 min	
Temperatura di avviamento del ventilatore		d08		-50.0°C	0.0°C	-50.0°C	
Inserimento ventola durante sbrinamento 0: Fermato. 1: Avviato. 2: Avviato durante pump down e sbrinamento.		d09		0	2	1	
Sensore di sbrinamento (0=tempo, 1=S5, 2=S4)		d10		0	2	0	
Ritardo arresto pompa		d16		0 min	60 min	0 min	
Tempo max. di refrigerazione complessiva tra due sbrinamenti		d18		0 hours	48 hours	0 hours	
Sbrinamento su richiesta - Variazione della temperatura di S5 consentita durante la formazione di ghiaccio. Sull'impianto centrale scegliere 20 K (=off)		d19		0.0 K	20.0 k	20.0 K	
Minima durata dello sbrinamento		d24		0 min	180 min	0 min	
Ventilatore							
Arresto ventola al disinserimento del compressore		F01		no	yes	no	
Ritardo arresto ventola		F02		0 min	30 min	0 min	
Temperatura di arresto ventola (S5)		F04		-50.0°C	50.0°C	50.0°C	
Orologio in tempo reale							
Sei tempi di avviamento per lo sbrinamento. Impostazione delle ore. 0=OFF		t01-t06		0 hours	23 hours	0 hours	
Sei tempi di avviamento per lo sbrinamento. Impostazione dei minuti. 0=OFF		t11-t16		0 min	59 min	0 min	

Per iniziare bene :

- 1 Aprire il parametro r12 e arrestare la regolazione.
- 2 Selezionare la connessione elettrica in base agli schemi di pagina 1
- 3 Aprire il parametro o61 e impostare i collegamenti elettrici
- 4 Selezionare una delle impostazioni predefinite dalla tabella di pagina 16
- 5 . Aprire il parametro o62 e impostare il numero del gruppo di impostazioni predefinite. Le impostazioni selezionate vengono trasferite al menù
6. La regolazione è avviata (r12 può essere impostato a 1 al punto 5)
- 7 Rivedere le impostazioni di fabbrica. I valori nelle caselle grigie sono cambiati in funzione delle impostazioni prescelte. Apportare tutte le modifiche necessarie ai relativi parametri.
- 8 Per la rete. Impostare l'indirizzo in o03 e trasmetterlo al gateway/unità di sistema con l'impostazione di o04.

Orologio - Impostazione delle ore	***	t07			0 hours	23 hours	0 hours	
Orologio - Impostazione dei minuti	***	t08			0 min	59 min	0 min	
Orologio - Impostazione della data	***	t45			1	31	1	
Orologio - Impostazione del mese	***	t46			1	12	1	
Orologio - Impostazione dell'anno	***	t47			0	99	0	
Varie								
Ritardo segnali d'uscita dopo l'avviamento		o01			0 s	600 s	5 s	
Segnale in ingresso a DI1. Funzione: 0=non usato. 1=stato di DI1. 2=funzione sportello con allarme, se aperto. 3=allarme sportello, se aperto. 4=avvio sbrinamento (segnale di impulsi). 5=interruttore princ. est. 6=funzionamento notturno 7=modifica riferimento (attiva r40). 8=funzione allarme, se chiuso. 9=funzione allarme, se aperto. 10=pulizia banco (segnale di impulsi). 11=raffreddamento forzato. 12=S5B.		o02			1	12	0	
Indirizzo di rete		o03			0	240	0	
Interruttore On/Off (messaggio PIN) IMPORTANTE! impostare o61 prima di o04		o04			OFF	ON	OFF	
Codice di accesso 1 (tutte le impostazioni)		o05			0	100	0	
Tipo di sensore utilizzato (Pt /PTC/NTC)		o06			Pt	ntc	Pt	
Visualizzazione stadio = 0,5 (normale 0,1 al sensore Pt)		o15			no	yes	no	
Tempo massimo di mantenimento dopo sbrinamento master/slave		o16			0 min	60 min	20	
Selezione segnale per visualizzazione display. S4% (100%=S4, 0%=S3)		o17			0%	100%	100%	
Segnale in ingresso su DI2. Funzione: (0=non usato. 1=stato di DI2. 2=funzione sportello con allarme, se aperto. 3=allarme sportello, se aperto. 4=avvio sbrinamento (pressione di impulsi). 5=Interruttore principale est. 6=funzionamento notturno 7=modifica riferimento (attiva r40). 8=funzione allarme, se chiuso. 9=funzione allarme, se aperto. 10=pulizia banco (pressione di impulsi). 11=raffreddamento forzato. 12=sbrinamento coordinato)		o37			0	12	0	
Configurazione della funzione illuminazione (relè 4) 1=ON durante funzionamento notturno. 2=ON/OFF mediante trasmissione dati. 3=ON segue la funzione DI, quando DI è selezionato su funzione sportello o su allarme sportello		o38			1	3	1	
Attivazione del relè luci (solo se o38=2)		o39			OFF	ON	OFF	
Tempo di attivazione resistenze antiappannanti durante il funzionamento diurno		o41			0%	100%	100%	
Tempo di attivazione resistenze antiappannanti durante il funzionamento notturno		o42			0%	100%	100%	
Tempo resistenze antiappannanti (tempo di On + tempo di Off)		o43			6 min	60 min	10 min	
Pulizia scomparto 0=nessuna pulizia della custodia. 1=Solo ventole. 2=Tutte le uscite OFF.	***	o46			0	2	0	
Selezione del diagramma EL. Vedi sintesi a pagina 1	*	o61	1	2	3	1	3	1
Trasferimento impostazioni predefinite Vedere pagina 16.	*	o62			0	10	0	
Codice di accesso 2 (accesso parziale)	***	o64			0	100	0	
Salvataggio delle impostazioni correnti dei regolatori sul tasto di programmazione. Selezione del proprio numero.		o65			0	25	0	
Caricamento di una serie di impostazioni dal tasto di programmazione (precedentemente salvate mediante la funzione o65)		o66			0	25	0	
Sostituzione delle impostazioni di fabbrica dei regolatori con quelle attuali		o67			OFF	On	OFF	
Servizio								
Codici di stato		S0-S33						
Temperatura misurata con il sensore S5	***	u09						
Stato su ingresso DI1 on/1=chiuso		u10						
Temperatura misurata con il sensore S3	***	u12						
Stato funzione notturna (On oppure Off) 1=chiuso	***	u13						
Temperatura misurata con il sensore S4	***	u16						
Temperatura del sensore termostatico		u17						
Lettura del riferimento di regolazione attuale		u28						
Stato su ingresso DI2 on/1=chiuso		u37						
Temperatura indicata sul display		u56						
Temperatura misurata per allarme termostato		u57						
Stato relè per raffreddamento	**	u58						
Stato relè per ventilatore	**	u59						
Stato relè per sbrinamento	**	u60						
Stato relè per resistenze antiappannanti	**	u61						
Stato relè per allarme	**	u62						
Stato relè per luce	**	u63						
Temperatura misurata con il sensore S5B	***	u75						
Stato rilevamento copertura notte (On = copertura notte rilevata)		U08						
Codici di errore								
E 1	Guasti del regolatore							
E 6	Errore nell'orologio in tempo reale. Controllare la batteria / reimpostare l'orologio.							
E 25	Errore del sensore in S3							
E 26	Errore del sensore in S4							
A 27	Errore del sensore in S5							
E 37	Errore del sensore in S5B							
Codici di allarme								
A 1	Allarme alta temperatura							
A 2	Allarme bassa temperatura							
A 4	Allarme porta aperta							
A 5	Informazioni. Il parametro o16 è scaduto							
A 8	Allarme alta temperatura S3							
A 9	Allarme bassa temperatura S3							
A 15	Allarme. Segnale dall'ingresso DI1							
A 16	Allarme. Segnale dall'ingresso DI2							
A 45	Condizione di standby (refrigerazione bloccata da r12 o ingresso DI)							
A 59	Pulizia scomparto Segnale dall'ingresso DI1 o DI2							
A 81	Commutare sensori S3 e S4?							
Stato operativo								
S0	Campo							
S 1	Attesa termine sbrinamento coordinato							
S 2	Se il compressore è in marcia, deve funzionare per X minuti.							
S 3	Quando il compressore si ferma, deve restare fermo per almeno X minuti							
S 4	L'evaporatore è in fase di gocciolamento per il tempo impostato							
S 10	Refrigerazione interrotta dall'interruttore principale Tramite r12 o ingresso digitale DI							
S 11	Refrigerazione interrotta dal termostato							
S 14	Sequenza sbrinamento: Sbrinamento in atto							
S 15	Sequenza sbrinamento: Ritardo ventilatore, acqua trattenuta nell'evaporatore							
S 17	Porta aperta. Ingresso DI aperto							
S 20	Raffreddamento di emergenza							
S 25	Controllo manuale delle uscite							
S 29	Pulizia scomparto							
S 30	Raffreddamento forzato							
S 32	Ritardo attivazione uscite all'avviamento							
non	Impossibile visualizzare la temperatura di sbrinamento. Arresto basato sul tempo							
-d-	Sbrinamento in corso / Prima refrigerazione dopo lo sbrinamento							
PS	PS: Richiesta password. Impostare password							

*) Può essere impostato solo se la regolazione è interrotta (r12=0)

**) Può essere controllato manualmente ma solo quando r12=-1

***) Con codice di accesso 2 l'accesso a questi menu è limitato

Impostazione di fabbrica
se si vuol tornare ai valori di taratura di fabbrica, si può:
- togliere la tensione di alimentazione al regolatore
- riconnettere la tensione di alimentazione tenendo premuti entrambi i pulsanti contemporaneamente.

Trasferimento impostazioni predefinite al regolatore. o62 =		1	2	3	4	5	6	7	8	9	10
Funzione / Codice											
Funzionam. normale											
Temperatura (setpoint)	---	-8.0°C	-32.0°C	-30.0°C	-32.0°C	-28.0°C	-28.0°C	-2.0°C	-1.5°C	0.5°C	-2.0°C
Termostato											
Differenziale	r01	4.0 K	4.0 K	1.0 K	4.0 K	1.0 K	1.0 K	1.0 K	1.0 K	1.0 K	2.0 K
Limite max. per l'impostazione del setpoint	r02	-5.0°C	-28.0°C	-28.0°C	-28.0°C	-25.0°C	-25.0°C	5.0°C	6.0°C	4.0°C	50.0°C
Limite min. per l'impostazione del setpoint	r03	-10.0°C	-34.0°C	-34.0°C	-34.0°C	-50.0°C	-50.0°C	-10.0°C	-2.0°C	-1.0°C	-50.0°C
Servizio manuale, arresto regolazione, avvio regolazione (-1, 0, 1)	r12	1	1	1	1	1	1	1	1	1	0
Scostamento notturno della temperatura	r13	0	0	0	0	0	0	0	3 K	3 K	0
Valore di spostamento del riferimento	r40	0	0	0	0	6 K	0	0	-1.5 K	0.5 K	0
Selezione della sonda del termostato S4% durante il funzionamento notturno con coperture notturne.	r61	0	0	0	100%	0	0	0	0	0	100%
Differenza di temperatura per la copertura notte	r75	0	0	0	0	0	0	0	3 K	3 K	0
Allarme											
Ritardo allarme temperatura	A03	30 min	30 min	30 min	30 min	10 min	10 min	30 min	10 min	10 min	30 min
Ritardo allarme temperatura dopo lo sbrinamento.	A12	60 min	60 min	60 min	60 min	35 min	35 min	60 min	45 min	45 min	90 min
Limite allarme per alta tensione	A13	13.0°C	-11.0°C	-11.0°C	-11.0°C	-15.0°C	-15.0°C	10.0°C	2.0°C	5.0°C	8.0°C
Limite allarme di bassa tensione	A14	-8.0°C	-32.0°C	-32.0°C	-35.0°C	-50.0°C	-50.0°C	-10.0°C	-50.0°C	-50.0°C	-30.0°C
Definizione del sensore allarme	A33	1	1	1	1	2	1	1	1	1	1
Segnale per il termostato con allarme. S4% (100%=S4, 0%=S3)	A36	0	0	0	100%	0	100%	0	100%	100%	100%
Limite allarme alto per S3	A56	13.0°C	-11.0°C	-11.0°C	-11.0°C	-16.0°C	-15.0°C	10.0°C	50.0°C	50.0°C	8.0°C
Limite allarme basso per S3	A57	-8.0°C	-32.0°C	-32.0°C	-35.0°C	-50.0°C	-50.0°C	-10.0°C	-50.0°C	-50.0°C	-30.0°C
Compressor											
Inversione della funzione del relè per D01	c30	0	0	0	0	0	0	0	1	1	0
Sbrinamento											
Temperatura di arresto sbrinamento	d02	5.0°C	5.0°C	5.0°C	5.0°C	5.0°C	15.0°C	7.0°C	10.0°C	10.0°C	6.0°C
Intervallo tra due avviamenti dello sbrinamento	d03	12 hours	12 hours	48 hours	12 hours	24 hours	24 hours	6 hours	4 hours	4 hours	8 hours
Durata max sbrinamento	d04	45 min	45 min	45 min	45 min	60 min	45 min	40 min	35 min	35 min	45 min
Tempo gocciolamento	d06	0 min	2 min	2 min	2 min	10 min	10 min	0 min	0 min	0 min	0 min
Avviamento ritardato del ventilatore dopo lo sbrinamento	d07	0 min	3 min	0 min	3 min	5 min	5 min	0 min	0 min	0 min	0 min
Inserimento ventola durante sbrinamento	d09	Yes	No	Yes	No	No	No	Yes	Yes	Yes	Yes
Sensore di sbrinamento (0=tempo, 1=S5, 2=S4)	d10	0	0	0	0	0	0	0	S4	S4	0
Varie											
Ritardo segnali di uscita all'avviamento	o01	5 s	5 s	5 s	5 s	5 s	5 s	5 s	0	0	5s
Tipo di sensore utilizzato (Pt /PTC/NTC)	o06	NTC	NTC	NTC	NTC	NTC	NTC	NTC	NTC	NTC	Pt
Visualizzazione stadio = 0,5 (normale 0,1 al sensore Pt)	o15	Yes	Yes	Yes	Yes	Yes	Yes	Yes	No	No	No
Tempo massimo di mantenimento dopo sbrinamento master/slave	o16	20 min	20 min	25 min	25 min	15 min	15 min	20 min	30 min	30 min	20 min
Selezione segnale per visualizzazione display. S4% (100%=S4, 0%=S3)	o17	0	0	0	100%	0	100%	0	0	0	100%
Segnale in ingresso su DI2. Funzione:	o37	12	12	12	12	12	12	12	12	12	0
Resistenza antiappannanti in funzionamento diurno	o41	100%	100%	100%	100%	100%	100%	100%	0	0	100%
Resistenza antiappannanti in funzionamento notturno	o42	100%	100%	100%	100%	100%	100%	100%	0	0	100%

Tasti

Impostare il menù

1. Premere il tasto superiore finché appare il parametro r01.
2. Premere il tasto inferiore o superiore e individuare il parametro che si desidera modificare.
3. Premere il tasto centrale finché non viene visualizzato il valore del parametro
4. Premere il tasto inferiore o superiore e scegliere il nuovo valore
5. Premere nuovamente il pulsante centrale per bloccare il valore.

Disinserimento relè di allarme / recepimento allarme / vedere codici allarme

- Premere brevemente il pulsante superiore
In caso di codici di allarme multipli, vengono presentati in sequenza. Premere il tasto superiore o inferiore per far scorrere la sequenza di codici.

Impostare il valore di temperatura

1. Premere il tasto centrale finché non viene visualizzato il valore di temperatura.
2. Premere il tasto inferiore o superiore e scegliere il nuovo valore
3. Premere di nuovo il tasto centrale per concludere l'impostazione

Lettura della temperatura sul sensore di sbrinamento



- Premere brevemente il pulsante inferiore

Avvio manuale o interruzione di uno sbrinamento

- Premere il tasto inferiore per quattro secondi

LED sul pannello frontale

LED

-  = Refrigerazione
-  = Sbrinamento
-  = Funzionamento ventilatore

I LED lampeggiano in caso di allarme.