

037C3007

037C3007

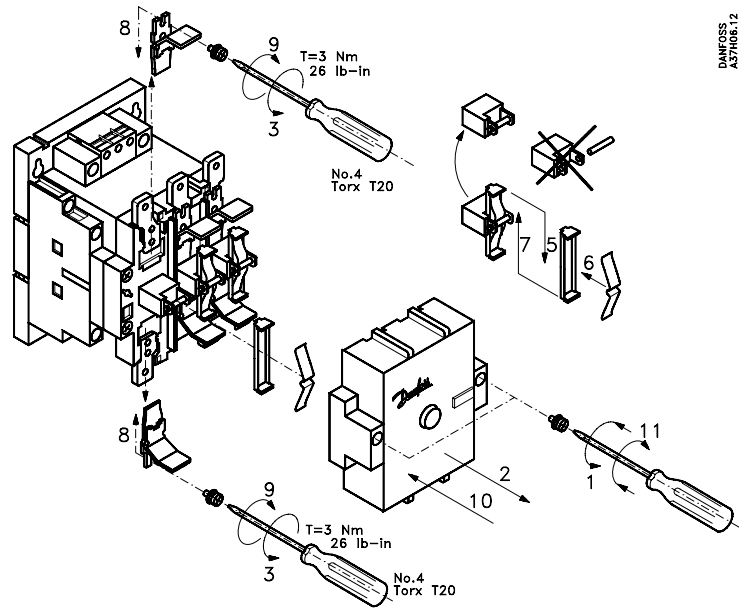

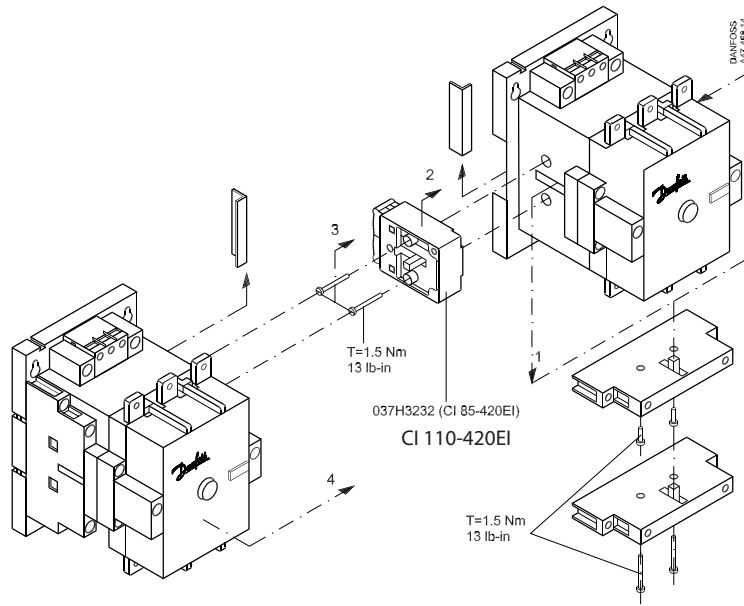

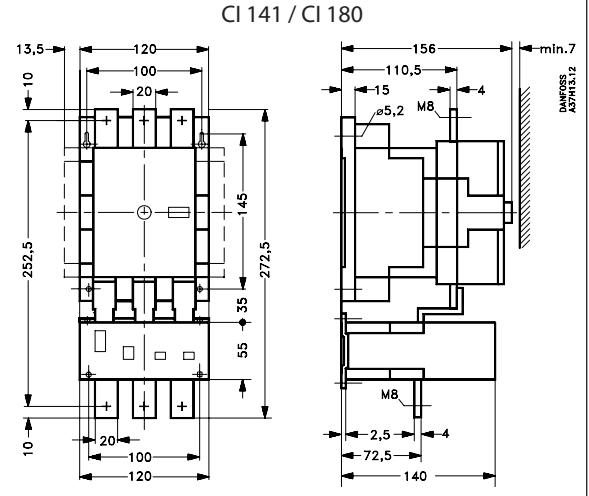
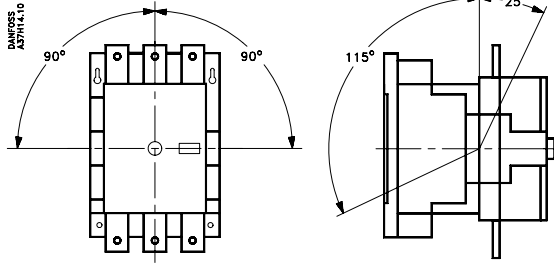
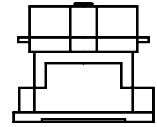

Contactors CI 141 / CI 180

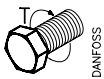

Instructions

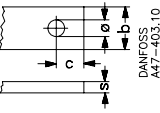
037C3007

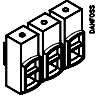
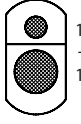
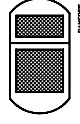
037C3007

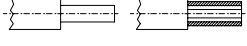
	Kit		DANFOSS A47-401.10
L1 1 L2 3 L3 5			\varnothing min = 8.3 mm b max = 25 mm c max = 12.5 mm s max = 5 mm
2 T1 4 T2 6 T3	CI 180 HU 	6 AWG-250 MCM	8...10 Nm or 70...90 lb-in. 90...110 lb-in.
0373247 		16-50 mm ² 16-120 mm ²	
		3-9 x 20 mm 3-14 x 20 mm	10...12 Nm or 90...110 lb-in.
13 83 14 84 A1 — A2			DANFOSS A47-405.10
		2 x 1...4 mm ² 2 x 1...2.5 mm ²	1.4...2.3 Nm
		2 x No. 16 AWG...12 AWG	12...20 lb in.

