

GEA Bock Compressor HG88e

Assembly instructions

HG88e/2735-4
HG88e/3235-4

HG88e/2735-4 S
HG88e/3235-4 S

HGX88e/2735-4
HGX88e/3235-4

HGX88e/2735-4 S
HGX88e/3235-4 S

About these instructions

Read these instructions before assembly and before using the compressor. This will avoid misunderstandings and prevent damage. Improper assembly and use of the compressor can result in serious or fatal injury.

Observe the safety instructions contained in these instructions.

These instructions must be passed onto the end customer along with the unit in which the compressor is installed.

Manufacturer

GEA Bock GmbH
72636 Frickenhausen

Contact

GEA Bock GmbH
Benzstraße 7
72636 Frickenhausen
Germany

GB

Telephone +49 7022 9454 0
Fax +49 7022 9454 137
refrigeration@gea.com
www.gea.com

Contents

Page

1	Safety	4
1.1	Identification of safety instructions	
1.2	Qualifications required of personnel	
1.3	General safety instructions	
1.4	Intended use	
2	Product description	6
2.1	Short description	
2.2	Name plate	
2.3	Type key	
3	Areas of application	8
3.1	Refrigerants	
3.2	Oil charge	
3.3	Limits of application	
4	Compressor assembly	11
4.1	Storage and transport	
4.2	Setting up	
4.3	Pipe connections	
4.4	Pipes	
4.5	Laying suction and pressure lines	
4.6	Operating the shut-off valves	
4.7	Operating mode of the lockable service connections	
5	Electrical connection	15
5.1	Information for contactor and motor contactor selection	
5.2	Standard motor, design for direct or partial winding start	
5.3	Basic circuit diagram for partial winding start with standard motor	
5.4	Special motor: design for direct or star-delta start	
5.5	Circuit diagram for star-delta start 230 V Δ / 400 V Y	
5.6	Electronic trigger unit INT69 G	
5.7	Connecting the trigger unit INT69 G	
5.8	Functional test of the trigger unit INT69 G	
5.9	Oil sump heater (accessories)	
6	Commissioning	26
6.1	Preparations for start-up	
6.2	Pressure strength test	
6.3	Leak test	
6.4	Evacuation	
6.5	Refrigerant charge	
6.6	Start-up	
6.7	Avoid slugging	
6.8	Connection of oil level regulator	
7	Maintenance	28
7.1	Preparation	
7.2	Work to be carried out	
7.3	Spare parts recommendation	
7.4	Extract from the lubricants table	
7.5	Decommissioning	
8	Accessories	30
8.1	Capacity regulator	
9	Technical data	32
10	Dimensions and connections	34
11	Declaration of conformity and installation	36
12	Service	37

GB

1| Safety

1.1 Identification of safety instructions:



DANGER

Indicates a dangerous situation which, if not avoided, will cause immediate fatal or serious injury.



WARNING

Indicates a dangerous situation which, if not avoided, may cause fatal or serious injury.



CAUTION

Indicates a dangerous situation which, if not avoided, may cause fairly severe or minor injury.



ATTENTION

Indicates a situation which, if not avoided, may cause property damage.



INFO

Important information or tips on simplifying work.

GB

1.2 Qualifications required of personnel



WARNING

Inadequately qualified personnel poses the risk of accidents, the consequence being serious or fatal injury. Work on compressors is therefore reserved for personnel which is qualified to work on pressurized refrigerant systems:

- For example, a refrigeration technician, refrigeration mechatronic engineer. As well as professions with comparable training, which enables personnel to assemble, install, maintain and repair refrigeration and air-conditioning systems. Personnel must be capable of assessing the work to be carried out and recognising any potential dangers.

1| Safety

1.3 Safety instructions



WARNING

Risk of accidents.

Refrigerating compressors are pressurised machines and as such call for heightened caution and care in handling.

The maximum permissible overpressure must not be exceeded, even for testing purposes.

Risk of burns!

- Depending on the operating conditions, surface temperatures of over 60°C on the discharge side or below 0°C on the suction side can be reached.

- Avoid contact with refrigerant necessarily.

Contact with refrigerant can cause severe burns and skin damage.

1.4 Intended use



WARNING

The compressor may not be used in potentially explosive environments!

GB

These assembly instructions describe the standard version of the compressor named in the title manufactured by GEA Bock. GEA Bock refrigerating compressors are intended for installation in a machine (within the EU according to the EU Directives 2006/42/EC Machinery Directive, 97/23/EC Pressure Equipment Directive).

Commissioning is permissible only if the compressor has been installed in accordance with these assembly instructions and the entire system into which it is integrated has been inspected and approved in accordance with legal regulations.

The compressors are intended for use in refrigeration systems in compliance with the limits of application.

Only the refrigerant specified in these instructions may be used.

Any other use of the compressor is prohibited!

2| Product description

2.1 Short description

- Semi-hermetic eight-cylinder reciprocating compressor with suction-gas cooled drive motor.
- The stream of refrigerant sucked out of the evaporator flows over the motor and cools it intensively. In this way, the motor can be kept at a relatively low temperature level, particularly under high loads.

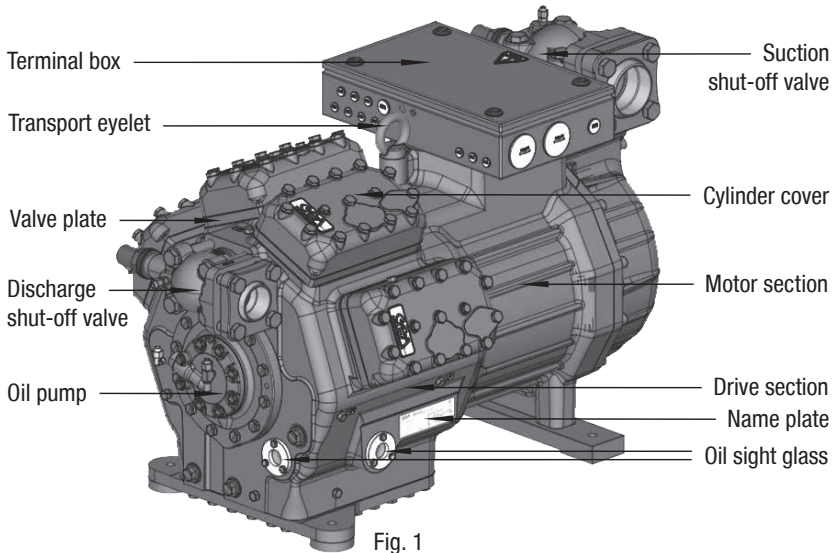

Dimension and connection values can be found in Chapter 10

2| Product description

2.2 Name plate (example)



 GEA Bock GmbH 72636 Frickenhausen, Germany			
1	Typ : HGX88e/3235-4	380-420VΔ/YYY	-3- 50HZ
2	Nr. : AW09529A044	n : 1450 min ⁻¹	V _{th} : 281 m ³ /h
3	I _{max} : 135,0 A	440-480VΔ/YYY	-3- 60HZ
4	I _{block} Δ: 475A YYY: 551A	n : 1740 min ⁻¹	V _{th} : 338 m ³ /h
5	P _{max} : ND(LP) / HD(HP)=19/28 bar	IP 65	Öl: SE 55
6			

Fig. 2

1	Type designation	7	Voltage, circuit, frequency
2	Machine number	8	Nominal rotation speed
3	Type code	9	Displacement
4	Maximum operating current	10	Voltage, circuit, frequency
5	Starting current (rotor blocked)	11	Nominal rotation speed
	Δ: Part winding 1	12	Displacement
	YYY: Part windings 1 and 2	13	Oil type filled at the factory
	Y: Part winding 1	14	Terminal box protection type
	YY: Part windings 1 and 2		
6	ND (LP): max. admissible over pressure Low pressure side		
	HD (HP): max. admissible over pressure High pressure side		

 **Observe the limits of application diagrams!**

 **Electrical accessories can change the IP protection class!**

GB

2.3 Type key (example)

HG X 88 e / 3235-4 S

—	Motor variant ³⁾
—	Number of poles
—	Swept volume
—	e-series
—	Numbers of cylinders
—	Size
—	Oil charge ²⁾
—	Series ¹⁾

1) HG - Hermetic Gas-Cooled (suction gas-cooled) for the normal- / air conditioning applications

2) X - Ester oil charge (HFC refrigerant, e.g. R134a, R404A/R507, R407C, R407F)

3) S - More powerful motor, e.g. for air-conditioning applications

3| Areas of application

3.1 Refrigerants

- HFKW / HFC: R134a, R404A/R507, R407C, R407F
- (H)FCKW / (H)CFC: R22

3.2 Oil charge

- The compressors are filled at the factory with the following oil type:
 - for R134a, R404A/R507, R407C, R407F FUCHS Reniso Triton SE 55
 - for R22 FUCHS Reniso SP 46

Compressors with ester oil charge (FUCHS Reniso Triton SE 55) are marked with an X in the type designation (e.g. HGX88e/3235-4).



INFO

For refilling, we recommend the above oil types.
Alternatives: see lubricants table, Chapter 7.4.



ATTENTION

The oil level must be in the visible part of the sight glass; damage to the compressor is possible if overfilled or underfilled!

max.

oil level

min.

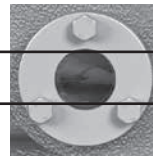

≈ 3,0 Ltr.

Fig. 3

GB

3.3 Limits of application



ATTENTION

Compressor operation is possible within the operating limits shown in the diagrams. Please note the significance of the shaded areas. Thresholds should not be selected as design or continuous operation points.

- Permissible ambient temperature (-20°C) - (+60°C)
- Max. permissible discharge end temperature 140°C.
- Max. permissible switching frequency 12x /h.
- A minimum running time of 3 min. steady-state condition (continuous operation) must be achieved.

For operation with supplementary cooling:

- Use only oils with high thermal stability.
- Avoid continuous operation near the threshold.
- Additional fans (accessories) can be used for additional cooling.

For operation with capacity regulator:

- The suction gas superheat temperature may need to be reduced or set individually when operating near to the threshold.
- The limits of application are reduced.

For operation with frequency converter:

- The maximum current and power consumption must not be exceeded. In the case of operation above the mains frequency, the application limit can therefore be limited.

When operating in the vacuum range, there is a danger of air entering on the suction side. This can cause chemical reactions, a pressure rise in the condenser and an elevated compressed-gas temperature. Prevent the ingress of air at all costs!

3| Areas of application

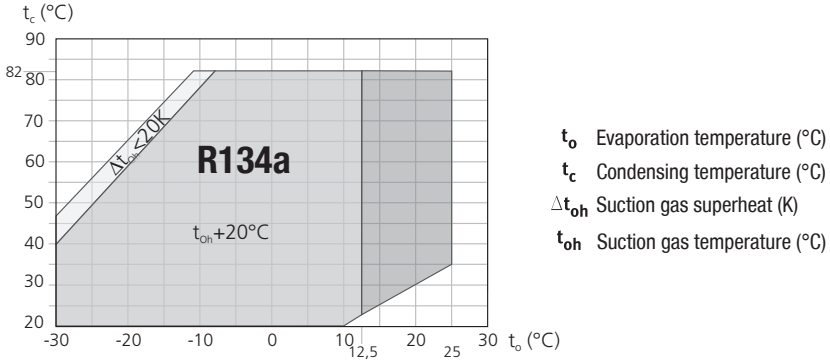

Fig. 4

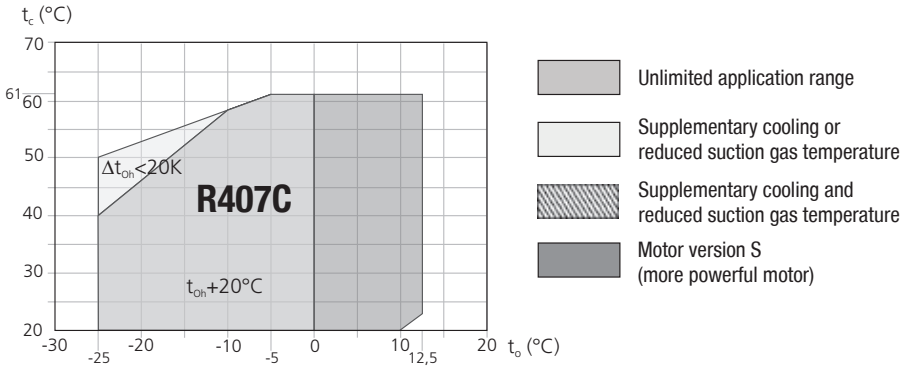

Fig. 5

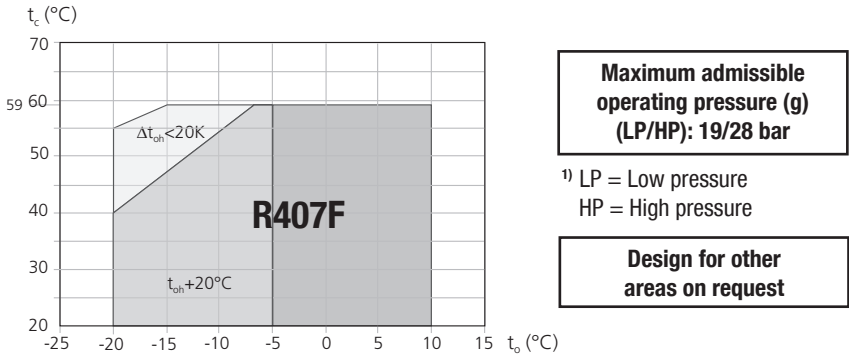

Fig. 6

96260-11.2014-DGbFEIRu

GB

3| Areas of application

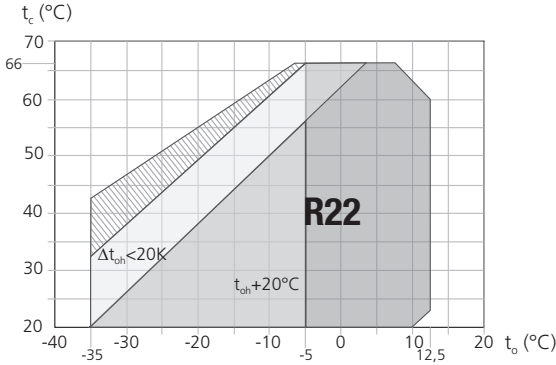

Fig. 7

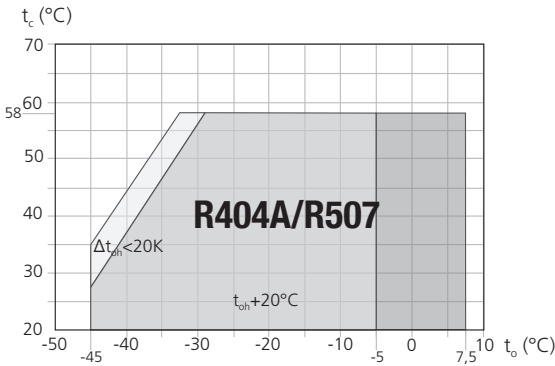





Fig. 8

-  Unlimited application range
-  Supplementary cooling or reduced suction gas temperature
-  Supplementary cooling and reduced suction gas temperature
-  Motor version S (more powerful motor)

t_o Evaporation temperature (°C)

t_c Condensing temperature (°C)

Δt_{oh} Suction gas superheat (K)

t_{oh} Suction gas temperature (°C)

**Maximum admissible operating pressure (g)
(LP/HP): 19/28 bar**

¹⁾ LP = Low pressure
HP = High pressure

Design for other areas on request

GB

4| Compressor assembly



INFO

New compressors are factory-filled with inert gas (3 bar nitrogen). Leave this service charge in the compressor for as long as possible and prevent the ingress of air. Check the compressor for transport damage before starting any work.

4.1 Storage and transport



Fig. 9



Fig. 10

- Storage at (-30°C) - (+70°C), maximum permissible relative humidity 10% - 95%, no condensation
- Do not store in a corrosive, dusty, vaporous atmosphere or in a combustible environment.
- Use transport eyelet.
- Do not lift manually!
- Use lifting gear!

4.2 Setting up



ATTENTION

Attachments (e.g. pipe holders, additional units, fastening parts, etc.) directly to the compressor are not permissible!

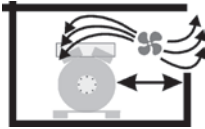

Fig. 11

- Provide adequate clearance for maintenance work.
- Ensure adequate compressor ventilation.



Fig. 12

- Do not use in a corrosive, dusty, damp atmosphere or a combustible environment.

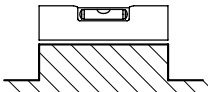

Fig. 13

- Setup on an even surface or frame with sufficient load-bearing capacity.
- Single compressor preferably on vibration damper.
- Duplex and parallel circuits always rigid.
- On shell and tube condensers, install only with rubber-metal shock mountings.



Fig. 14

- Installation of pipe vibration mufflers is recommended!

GB

4| Compressor assembly

4.3 Pipe connections



ATTENTION **Damage possible.**
Superheating can damage the valve.
Remove the pipe supports from the valve for soldering.
Only solder using inert gas to inhibit oxidation products (scale).
The discharge gas connection can be moved upwards with an adapter (accessory). This makes it easier to remove the compressor from a refrigerating system.

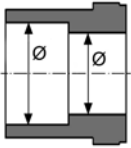

Fig. 15: graduated internal diameter

- Pipe connections on the compressor are available for soldering or welding (accessories). The **discharge and suction line valves** have graduated inside diameters so that pipes with standart millimetre and inch dimensions can be used. The pipe will be immersed more or less deeply according to dimension.
- The connection diameters of the shut-off valves are rated for maximum compressor output. **The actual required pipe cross section must be matched to the output. The same applies for non-return valves.**

GB

4.4 Pipes

- Pipes and system components must be clean and dry inside and free of scale, swarf and layers of rust and phosphate. Only use air-tight parts.
- Lay pipes correctly. Suitable vibration compensators must be provided to prevent pipes being cracked and broken by severe vibrations.
- Ensure a proper oil return.
- Keep pressure losses to an absolute minimum.

4| Compressor assembly

4.5 Laying suction and pressure lines



ATTENTION Improperly installed pipes can cause cracks and tears, the result being a loss of refrigerant.



INFO Proper layout of the suction and discharge lines directly after the compressor is integral to the system's smooth running and vibration behaviour.

A rule of thumb: Always lay the first pipe section starting from the shut-off valve **downwards** and **parallel to the drive shaft**.

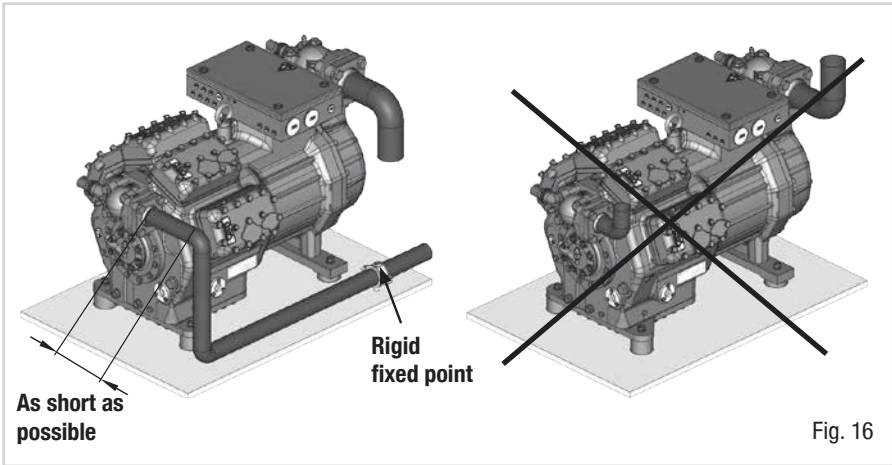

GB

4| Compressor assembly

4.6 Operating the shut-off valves

- Before opening or closing the shut-off valve, release the valve spindle seal by approx. $\frac{1}{4}$ of a turn counter-clockwise.
- After activating the shut-off valve, re-tighten the adjustable valve spindle seal clockwise.

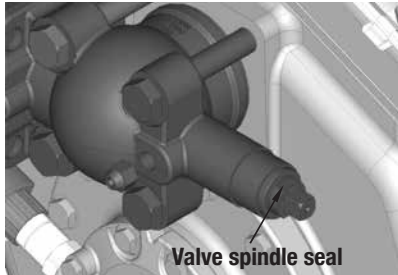

Fig. 17

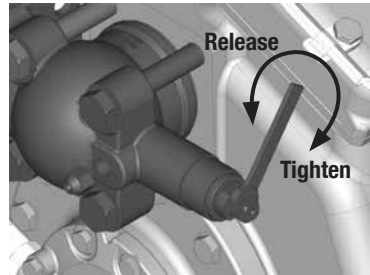

Fig. 18

4.7 Operating mode of the lockable service connections

GB

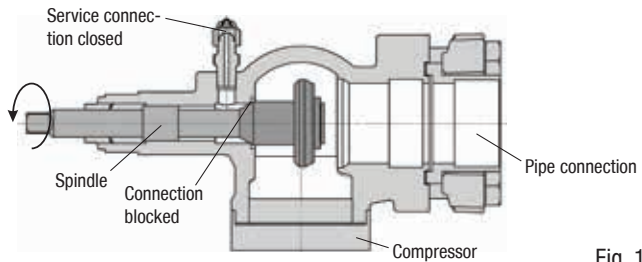

Fig. 19

Opening the shut-off valve:

Spindle: turn to the left (counter-clockwise) as far as it will go.

—> Shut-off valve completely opened / service connection closed.

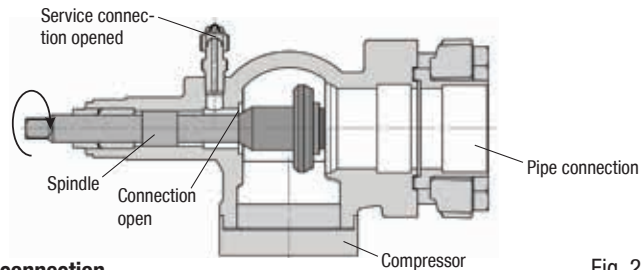

Fig. 20

Opening the service connection

Spindle: Turn $\frac{1}{2}$ - 1 turn clockwise.

—> Service connection opened / shut-off valve opened.

5| Electrical connection

5 Electrical connection



DANGER

Risk of electric shock! High voltage!

Only carry out work when the electrical system is disconnected from the power supply!



INFO

Connect the compressor motor in accordance with the circuit diagram (see inside of terminal box).

- Use suitable cable entry point of the correct protection type (see name plate) for routing cables into the terminal box. Insert the strain reliefs and prevent chafe marks on the cables.
- Compare the voltage and frequency values with the data for the mains power supply.

Only connect the motor if these values are the same.



5.1 Information for contactor and motor contactor selection

All protection devices and switching or monitoring units must be fitted in accordance with the local safety regulations and established specifications (e.g. VDE) as well as with the manufacturer's information. **Motor protection switches are required!** Motor contactors, feed lines, fuses and motor protection switches must be rated on the basis of the maximum working current (see name plate). For motor protection use a current-dependent and time-delayed overload protection device for monitoring all three phases. Set the overload protection device so that it must be actuated within 2 hours, if there is 1.2 times the max. working current.

GB

5| Electrical connection

5.2 Standard motor, design for direct or partial winding start

Designation on the name plate		Sticker on the terminal box	
until A044	from A047	until A044	from A047
Δ /YYY	Y/YY		

Compressors with this marking are suitable for direct or partial winding start. The motor winding is subdivided into two parts:

Until type code A044: Part winding 1 = 60% and part winding 2 = 40%. This winding division reduces the start-up current needed for a part winding start to approx. 65% of that for a direct start.

From type code A047: Part winding 1 = 50% and part winding 2 = 50%. This winding division reduces the start-up current needed for a part winding start to approx. 50% of that for a direct start.



INFO

A mechanical unloaded start with bypass solenoid valve is not required.

5| Electrical connection

The motor is wired for direct start (YYY resp. YY) at the factory. For part winding start Δ / YYY resp. Y/YY the bridges must be removed and the motor feed line connected according to the circuit diagram:

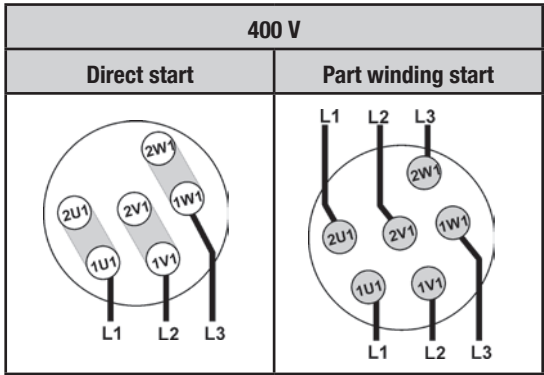

ATTENTION Failure to do this results in opposed rotary fields and results in damage to the motor. After the motor starts up via partial winding 1, partial winding 2 must be switched on after a maximum delay of one second. Failure to comply can adversely affect the service life of the motor.



INFO When testing coils with resistance tester, please note that partial winding 1 and partial winding 2 are wired internally in HG88e.

GB

5.3 Basic circuit diagram for part winding start with standart motor

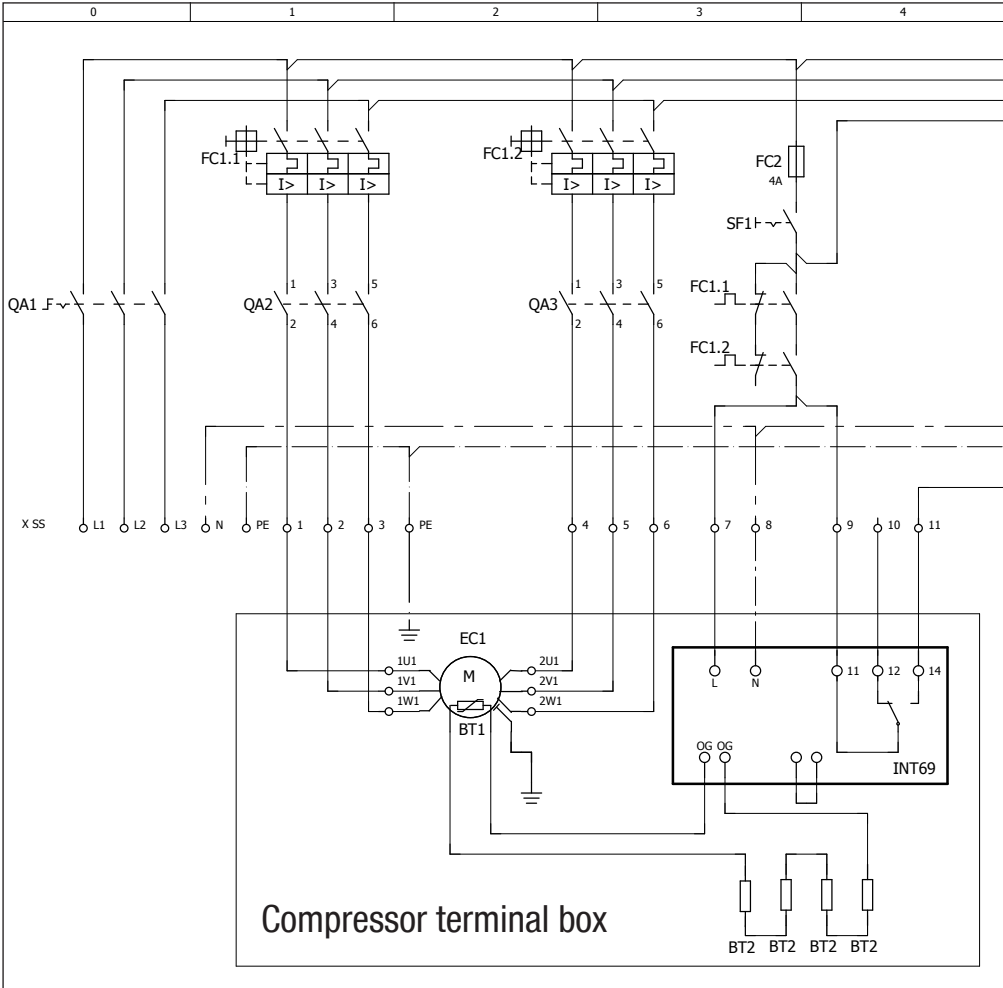
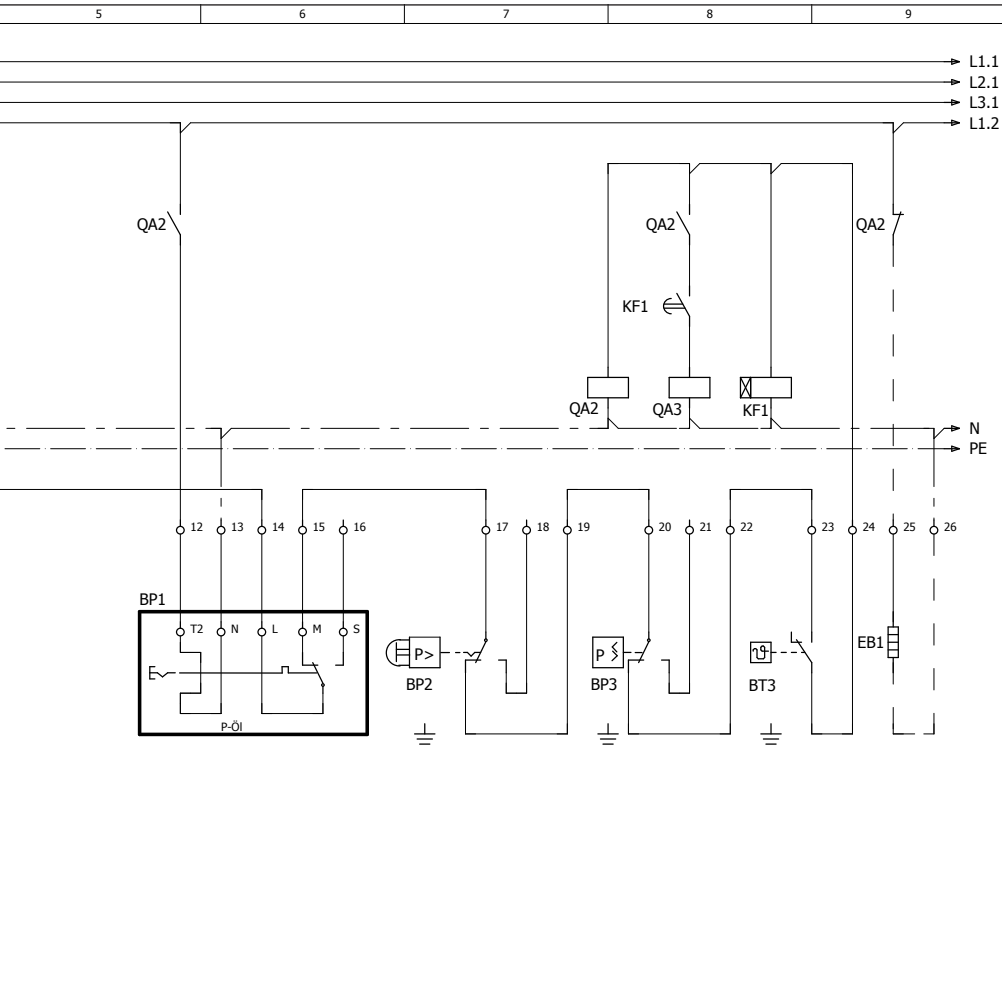

Fig. 21

BP1	Oil differential pressure monitor
BP2	High pressure safety monitor
BP3	Safety chain (high/low pressure monitoring)
BT3	Release switch (thermostat)
BT1	Cold conductor (PTC sensor) motor winding
BT2.X	Thermal protection thermostat
EB1	Oil sump heater
EC1	Compressor motor
FC1.1	Motor protection switch (part winding 1)



GB

FC1.2	Motor protection switch (part winding 2)
FC2	Control power circuit fuse
KF1	Delay relay max. 1s
QA1	Main switch
QA2	Mains contactor (part winding 1)
QA3	Mains contactor (part winding 2)
SF1	Control voltage switch
XSS	Terminal strip in the external switch cabinet

5| Electrical connection

5.4 Special motor: design for direct or star-delta start

A mechanical unloaded start with bypass solenoid valve (accessories) is required for the star-delta start.

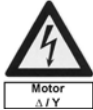
Designation on the name plate	Sticker on the terminal box
Δ / Y	

5| Electrical connection

Star-delta start-up is only possible for Δ (230 V) power supply. Example:

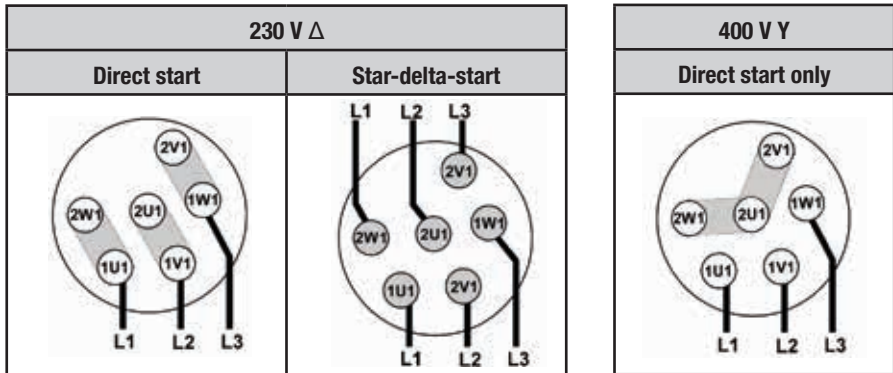

In the factory the motor is wired for direct starting at high voltage.
The bridges are to be removed for star delta starting at low voltage.

5.5 Circuit diagram for star-delta start 230 V Δ / 400 V Y

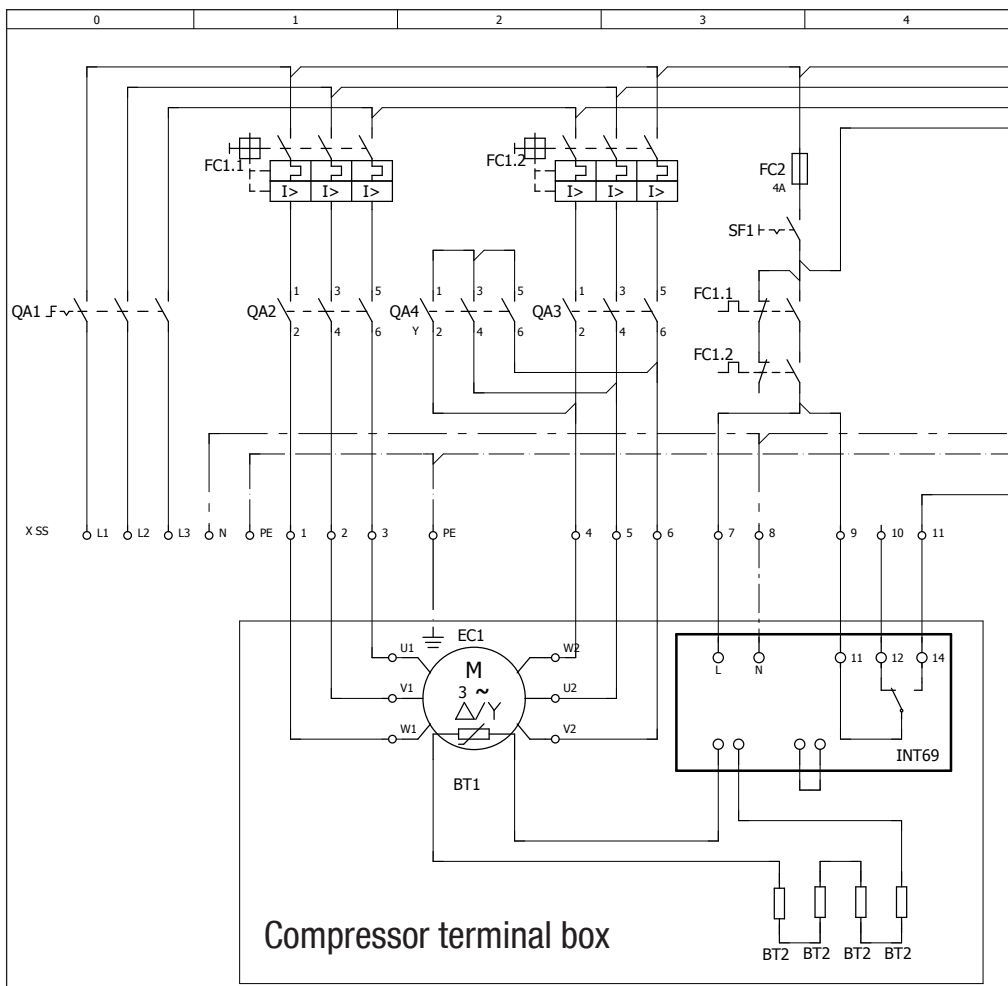
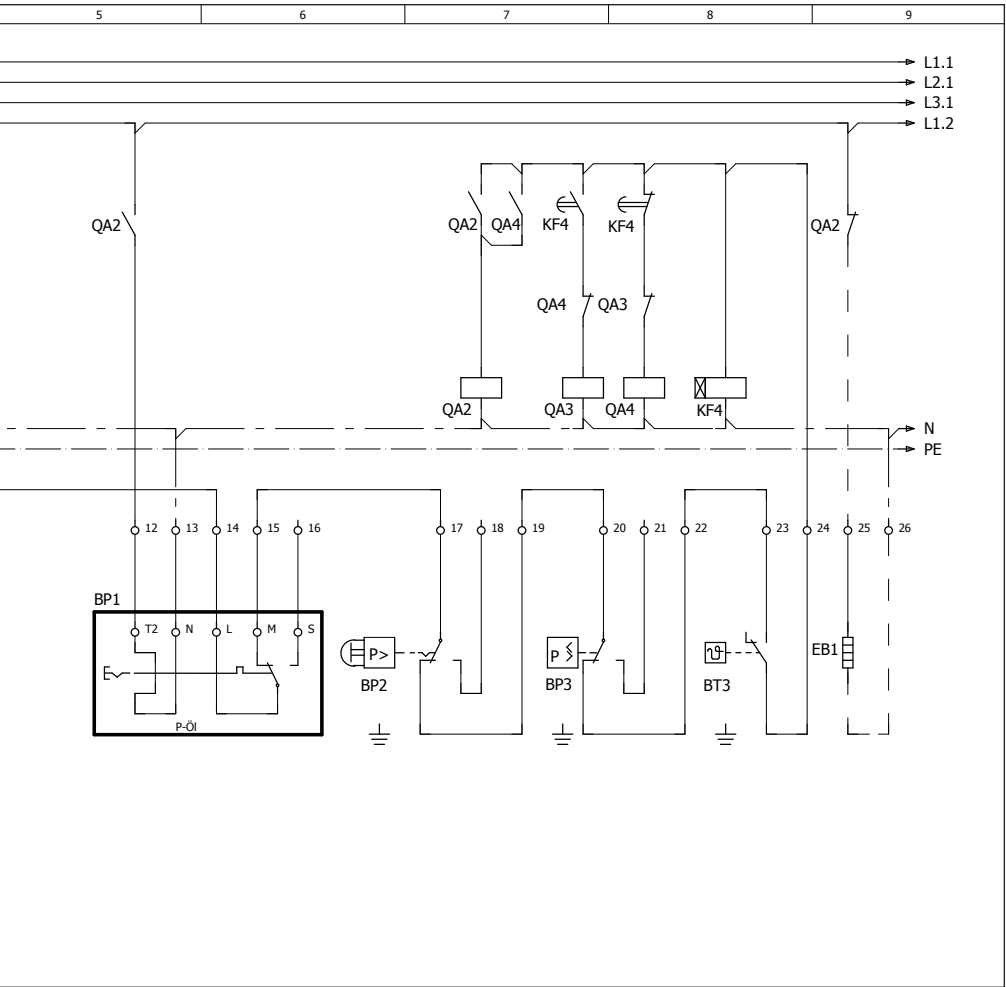

Fig. 22

BP1	Oil differential pressure monitor
BP2	High pressure safety monitor
BT2.X	Thermal protection thermostat
BP3	Safety chain (high/low pressure monitoring)
BT3	Release switch (thermostat)
EB1	Oil sump heater
EC1	Compressor motor
FC1.1	Motor protection switch (mains contactor)
FC1.2	Motor protection switch (Δ -contactor)



GB

FC2	Control power circuit fuse
KF4	Delay relay for contactor switch over
QA1	Main switch
QA2	Mains contactor
QA3	Δ-contactor
QA4	Y-contactor
SF1	Control voltage switch
XSS	Terminal strip in the external switch cabinet

5| Electrical connection

5.6 Electronic trigger unit INT69 G

The compressor motor is fitted with cold conductor temperature sensors (PTC) connected to the electronic trigger unit INT69 G in the terminal box. In case of excess temperature in the motor winding, the INT 69 G deactivates the motor contactor. Once cooled, it can be restarted only if the electronic lock of the output relay (terminals B1+B2) is released by interrupting the supply voltage.

The hot gas side of the compressor can also be protected against overtemperature using thermal protection thermostats (accessory).

The unit trips when an overload or inadmissible operating conditions occur. Find and remedy the cause.



INFO

The relay switching output is executed as a floating changeover contact. This electrical circuit operates according to the quiescent current principle, i.e. the relay drops into a the idle position and deactivates the motor contactor even in case of a sensor break or open circuit.

5.7 Connection of the trigger unit INT69 G



INFO

Connect the trigger unit INT69 G in accordance with the circuit diagram. Protect the trigger unit with a delayed-action fuse (F) of max. 4 A. In order to guarantee the protection function, install the trigger unit as the first element in the control power circuit.



ATTENTION

PTC cable on the trigger unit INT69 G and terminals PTC 1 and PTC 2 on the compressor terminal board must not come into contact with mains voltage. This would destroy the trigger unit INT69 G and PTC sensors.



Abb. 23
Terminal box

5| Electrical connection

5.8 Function test of the trigger unit INT69 G

Before commissioning, after troubleshooting or making changes to the control power circuit, check the functionality of the trigger unit. Perform this check using a continuity tester or gauge.

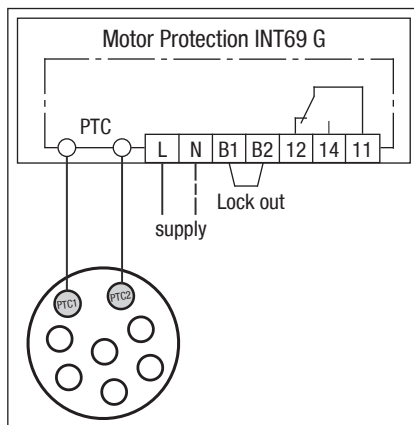
Gauge state	Relay position
Deactivated state	11-12
INT69 G switch-on	11-14
Remove PTC connector	11-12
Insert PTC connector	11-12
Reset after mains on	11-14

Relay position INT69 G

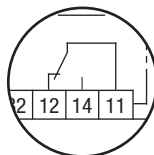

Fig. 24

5.9 Oil sump heater (accessories)

When the compressor is at a standstill, refrigerant diffuses into the lubricating oil of the compressors housing, depending on pressure and ambient temperature. This reduces the lubricating capacity of the oil. When the compressor starts up, the refrigerant contained in the oil evaporates out through the reduction in pressure. The consequences can be foaming and migration of the oil, causing oil shocks under certain circumstances.

GB

Operation: The oil sump heater operates when the compressor is at a standstill. When the compressor starts up, the oil sump heater switches off again automatically.

Connection: The oil sump heater must be connected via an auxiliary contact (or parallel wired auxiliary contact) of the compressor contactor to a separate electric circuit.

El. data: 230 V - 1 - 50/60 Hz, 200 W.

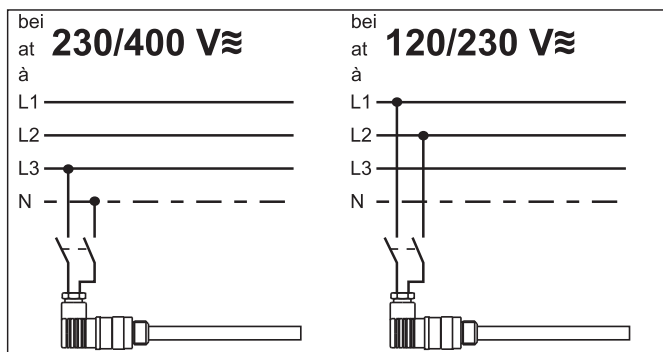

Fig. 25



ATTENTION Connection to the current path of the safety control chain is not permitted.

6| Commissioning

6.1 Preparations for start-up



INFO

To protect the compressor against inadmissible operating conditions, high pressure and low pressure pressostats are mandatory on the installation side.

The compressor has undergone trials in the factory and all functions have been tested. There are therefore no special running-in instructions.

Check the compressor for transport damage!

6.2 Pressure strength test



DANGER

Risk of bursting!

The compressor must only be pressurised using nitrogen (N₂). Never pressurise with oxygen or other gases!

The maximum permissible overpressure of the compressor must not be exceeded at any time during the testing process (see name plate data)! Do not mix any refrigerant with the nitrogen as this could cause the ignition limit to shift into the critical range.

The compressor has been factory-tested for pressure resistance. The following must be observed if the entire plant is subjected to an additional pressure strength test:

- Test the refrigeration circuit according to EN 378-2 or a corresponding safety standard.

6.3 Leak test



DANGER

Risk of bursting!

Do not mix any refrigerant with the nitrogen (N₂) as this could cause the ignition limit to shift into the critical range.

- Carry out the leak test of the refrigerating system in accordance with EN 378-2 or a corresponding safety standard **without including the compressor.**

6.4 Evacuation



ATTENTION

Do not start the compressor if it is under vacuum. Do not apply any voltage - even for test purposes (must only be operated with refrigerant).

Under vacuum, the spark-over and creepage current distances of the terminal board connection bolts shorten; this can result in winding and terminal board damage.

- First evacuate the **system** and then include **the compressor in the evacuation process.**
- Relieve the compressor pressure.
- Open the suction and pressure line shut-off valves.
- Evacuate the suction and discharge pressure sides using the vacuum pump.
- At the end of the evacuation process, the vacuum should be < 1.5 mbar when the pump is switched off.
- Repeat this process as often as is required.

6| Commissioning

6.5 Refrigerant filling



CAUTION

Wear personal protective clothing such as goggles and protective gloves!

- Make sure that the suction and pressure line shut-off valves are open.
- With the compressor switched off, add the liquid refrigerant directly to the condenser or receiver, breaking the vacuum.
- If the refrigerant needs topping up after starting the compressor, it can be topped up in vapour form on the suction side, or, taking suitable precautions, also in liquid form at the inlet to the evaporator.



ATTENTION

- **Avoid overfilling the system with refrigerant!**
- **To avoid shifts in concentration, zeotropic refrigerant blends must always only be filled into the refrigerating plant in liquid form.**
- **Do not pour liquid coolant through the suction line valve on the compressor.**
- **It is not permissible to mix additives with the oil and refrigerant.**

6.6 Start-up



WARNING

Ensure that both shut-off valves are open before starting the compressor!

- Check that the safety and protection devices (pressure switch, motor protection, electrical contact protection measures, etc.) are all functioning properly.
- Switch on the compressor and allow to run for a minimum of 10 min.
- **Check the oil level by:** The oil must be visible in the sightglass.



ATTENTION

**If larger quantities of oil have to be topped up, there is a risk of oil hammer effects.
If this is the case check the oil return!**

6.7 Avoiding slugging



ATTENTION

Slugging can damage the compressor and cause refrigerant to leak.

To prevent slugging:

- The complete refrigeration system must be properly designed.
- All components must be compatibly rated with each other with regard to output (particularly the evaporator and expansion valves).
- Suction gas superheat at the compressor input **should be min. 7 - 10 K**. (check the setting of the expansion valve).
- The system must reach a state of equilibrium.
- Particularly in critical systems (e.g. several evaporator points), measures are recommended such as replacement of liquid traps, solenoid valve in the liquid line, etc.

There should be no movement of coolant whatsoever while the compressor is at a standstill.

6 | Commissioning

6.8 Connection of oil level regulator

Oil level regulation systems have proven themselves with parallel circuits of several compressors. The connection "O" is provided for installing an oil level regulator (see dimensions drawing). All common oil level regulators from AC&R, ESK and Carly as well as the OM3 TraxOil oil level regulation system from Alco can be connected directly without adapters (see Fig. 25). A sight glass on the oil level regulator is not required.

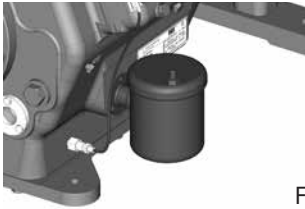
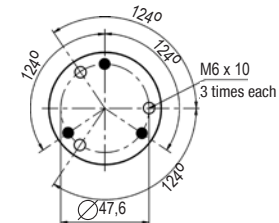

Fig. 26

Mechanical oil level regulator at the "O" connection



- 3 hole connection diagram for ESK, AC&R and CARLY
- 3 hole diagramm for TraxOil

GB

7 | Maintenance

7.1 Preparation



WARNING

Before starting any work on the compressor:

- Switch off the compressor and secure it to prevent a restart.
- Relieve compressor of system pressure.
- Prevent air from infiltrating the system!

After maintenance has been performed:

- Connect safety switch.
- Evacuate compressor.
- Release switch lock.

7.2 Work to be carried out

In order to guarantee optimum operational reliability and service life of the compressor, **we recommend** carrying out servicing and inspection work at regular intervals:

● Oil change:

- not mandatory for factory-produced series systems.
- for field installations or when operating near the application limit: for the first time after 100 to 200 operating hours, then approx. every 3 years or 10,000 - 12,000 operating hours. Dispose of used oil according to the regulations; observe national regulations.

- **Annual checks:** Oil level, leak tightness, running noises, pressures, temperatures, function of auxiliary devices such as oil sump heater, pressure switch.

7 | Maintenance

7.3 Recommended spare parts

HG88e / ...	2735-4 (S)	3235-4 (S)
Designation	Item No.	Item No.
Set of gaskets kit	81007	
Valve plate kit	81040	81041
Oil pump kit	80116	
Oil sump heater kit (220-240 V)	80237	

Only use genuine GEA Bock spare parts!

7.4 Extract from the lubricants table

The oil type filled as standard in the factory is marked on the **name plate**. **This oil type should be used as a preference.** Alternatives are stated in the extract from our lubricants table below.

Refrigerants	GEA Bock standard oil types	Recommended alternatives
HFC (e.g. R134a, R404A, R407C, R407F)	Fuchs Reniso Triton SE 55	Fuchs Reniso Triton SEZ 32 Esso/Mobil EAL Arctic 46 Sunoco Suniso SL 46 Texaco Capella HFC 55
HCFC (e.g. R22)	Fuchs Reniso SP 46	Fuchs Reniso SP 32 BP Energol LPT 46 Sunoco Suniso 3,5 GS Texaco Capella WF 46

GB

7.5 Decommissioning

Close the shut-off valves on the compressor. Drain the refrigerant (it must not be discharged into the environment) and dispose of it according to the regulations. When the compressor is depressurised, undo the fastening screws of the shut-off valves. Remove the compressor using an appropriate hoist. Dispose of the oil inside in accordance with the applicable national regulations.

8 | Accessories

8.1 Capacity regulator



ATTENTION If the capacity regulator is installed at the factory, the control component (pilot valve) is subsequently installed and connected by the customer. If the control component is not connected, the cylinder bank is switched off permanently. Damage to the compressor is possible!

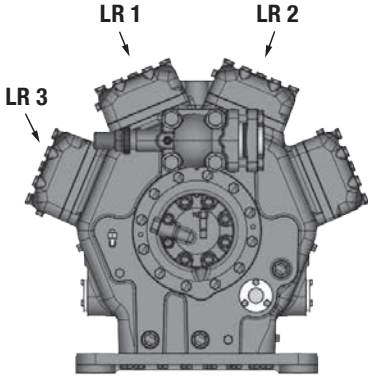
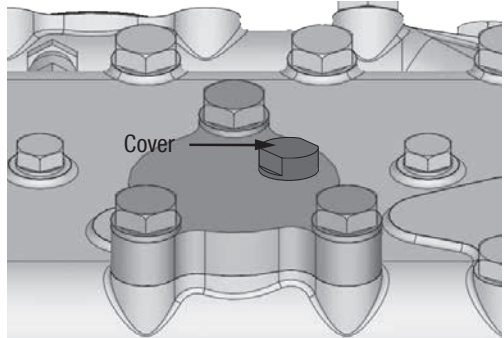

Fig. 27



Delivery condition (from the factory):
Capacity regulator installed with cover
(transport protection).

Fig. 28

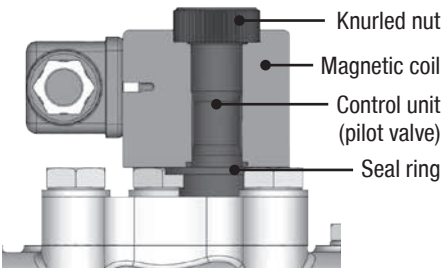

Fig. 29

Before start-up, remove the cover at the capacity regulator and replace it with the enclosed control unit (pilot valve).

**Attention! Compressor is under pressure!
Depressurize the compressor first.**

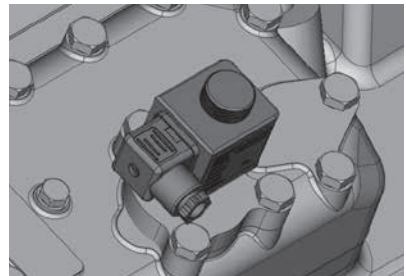

Fig. 30

Screw in control unit (pilot valve) with seal ring and tight with 15 Nm.
Wet thread sides with ester oil.
Insert magnetic coil, fasten it with knurled nut and connect it.



WARNING Several capacity regulators cannot switch at the same time during compressor operation! Otherwise the sudden change in load can damage the compressor! Comply with the switching interval of 60 s.

• Comply with the switching sequence:

Switching on LR1 — 60s → LR2 — 60s → LR3

Switching off LR3 — 60s → LR2 — 60s → LR1



ATTENTION

- **Capacity-regulated operation alters the gas speeds and pressure ratios of the refrigerating plant: Adjust the suction line routing and dimensioning accordingly, do not set the control intervals too close and do not let the system switch more than 12 times per hour (refrigerating plant must have reached a state of equilibrium). Continuous operation in the control stage is not recommended as the gas velocity in the plant system under certain circumstances does not guarantee sufficient oil return to the compressor with activated capacity regulator.**

We recommend switching to unregulated operation (100% capacity) for at least 5 minutes per capacity-regulated operating hour. An assured oil return can also be realised by a 100% capacity requirement after each compressor restart.

- **Electrical actuation of the solenoid valve: Normally open, (corresponds to 100 % compressor capacity).**

Special accessories are only premounted in the factory if ordered specially by customer. Retrofitting is possible in full compliance with the safety instructions and repair instructions enclosed with the kits. Information about the use, operation, maintenance and servicing of the components is available in the printed literature or on the internet under www.gea.com

9| Technical data until A044

Type	No. of cylinders	Displacement 50 / 60 Hz (1450 / 1740 rpm)	Electrical data ③				Weight	Connections ④		Oil charge
			Voltage ①	Max. Operating current ② PW 1 + 2	Max. power consumption ②	Starting current (rotor locked) PW 1 / PW 1 + 2		Discharge line DV	Suction line SV	
HG88e/2735-4		237,9 / 285,5	until A044	A	kW	A	kg	mm (inch)	mm (inch)	Ltr.
				118	63,7	475 / 551				
HG88e/2735-4 S	8	237,9 / 285,5	380-420 V Δ/YYY - 3 - 50 Hz PW 440-480 V Δ/YYY - 3 - 60 Hz PW PW = Part Winding Winding ratio : 60% / 40%	141	77,5	520 / 605	468	54 (2 1/8)	76 (3 1/8)	9,0
				135	74,6	475 / 551				
HG88e/3235-4		281,3 / 337,6		160	91,0	520 / 605	462			
HG88e/3235-4 S		281,3 / 337,6								

① Tolerance (\pm 10%) relative to the mean value of the voltage range.
Other voltages and types of current on request.

② - The specifications for max. power consumption apply for 50Hz operation.
For 60Hz operation, the specifications have to be multiplied by the factor 1.2. The max. working current remains unchanged.

- Take account of the max. operating current / max. power consumption for design of fuses, supply lines and safety devices. Fuse: Consumption category AC3

③ All specifications are based on the average of the voltage range
④ For solder connections

9| Technical data from A047

Type	No. of cylinders	Displacement 50 / 60 Hz (1450 / 1740 rpm)	Electrical data ③			Weight	Connections ④		Oil charge
			Voltage ①	Max. Operating current ② PW 1 + 2	Max. power consumption ②		Starting current (rotor locked) PW 1 / PW 1 + 2	Discharge line DV	
HG88e/2735-4		m ³ /h	from A047	A	kW	A	mm (inch)	Ltr.	
				114	63,7	475 / 551	mm (inch)	Ltr.	
HG88e/2735-4 S	8	237,9 / 285,5	380-420 V Y/YY - 3 - 50 Hz PW 440-480 V Y/YY - 3 - 60 Hz PW PW = Part Winding Winding ratio : 50% / 50%	135	77,5	520 / 605	54 (2 1/8)	76 (3 1/8)	9,0
				131	74,6	475 / 551			
HG88e/3235-4		281,3 / 337,6		160	91,0	520 / 605			
HG88e/3235-4 S		281,3 / 337,6							

① Tolerance (\pm 10%) relative to the mean value of the voltage range.

Other voltages and types of current on request.

② - The specifications for max. power consumption apply for 50Hz operation.
For 60Hz operation, the specifications have to be multiplied by the factor 1.2. The max. working current remains unchanged.

- Take account of the max. operating current / max. power consumption for design of fuses, supply lines and safety devices. Fuse: Consumption category AC3

③ All specifications are based on the average of the voltage range

④ For solder connections

10| Dimensions and connections

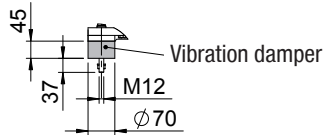
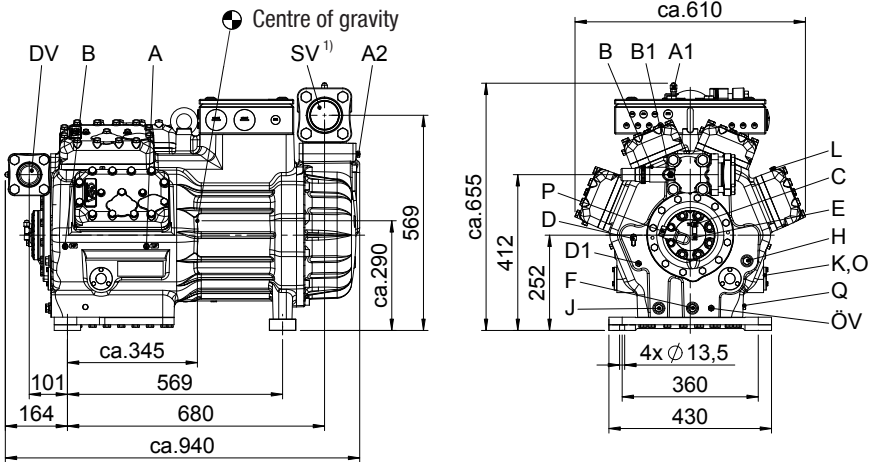

¹⁾ Suction cover 90° rotatable
Dimensions in mm

Fig. 31

Suction connection on the side left or right 90°

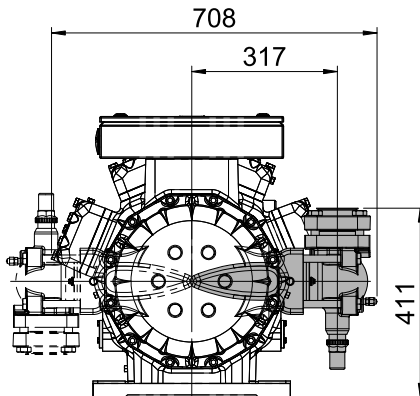

Fig. 32

10|Dimensions and connections

SV	Suction line	see technical data, Chapter 9	
DV	Discharge line		
A	Connection suction side,, not lockable		1/8" NPTF
A1	Connection suction side,, lockable		7/16" UNF
A2	Connection suction side,, not lockable		1/4" NPTF
B	Connection discharge side, not lockable		1/8" NPTF
B1	Connection discharge side, lockable		7/16" UNF
C	Connection oil pressure switch OIL		7/16" UNF
D	Connection oil pressure switch LP		7/16" UNF
D1	Connection oil return from oil separator		1/4" NPTF
E	Connection oil pressure gauge		7/16" UNF
F	Oil drain		M22 x 1,5
H	Oil charge plug		M22 x 1,5
J	Connection oil sump heater		M22 x 1,5
K	Sight glass		-
L	Connection thermal protection thermostat		1/8" NPTF
O	Connection oil level regulator		3 x M6
ÖV	Connection oil service valve		1/4" NPTF
P	Connection oil differential pressure sensor		M20 x 1,5
Q	Connection oil temperature sensor		1/8" NPTF

GB

11 | Declaration of conformity and installation

DECLARATION OF CONFORMITY CE 13

for using the compressors within the European Union
(in accordance with Low Voltage Directive 2006/95/EC)

We hereby declare that the following refrigerating compressors

Product designation: **HG88e**

comply with the Low Voltage Directive 2006/95/EC.

Applied harmonised standard:

EN 60034-1:2010

EN 60204-1:2006

DECLARATION OF INSTALLATION

for using the compressors within the European Union
(in accordance with Machinery Directive 2006/42/EC)

The manufacturer: GEA Bock GmbH, Benzstraße 7
72636 Frickenhausen, Tel.: 07022/9454-0

hereby declares that the refrigerating compressor **HG88e** complies with the basic requirements of Appendix II 1B of the Machinery Directive 2006/42/EC.

Applied harmonised standard:

EN 12693:2008 and the corresponding standards referenced

A partly completed machine may only be put into operation when it has been established that the machine, into which the partly completed machine is to be installed, conforms to the regulations of the Machinery Directive (2006/42/EC).

The manufacturer undertakes to transmit electronically the special documentation required by individual states for partly completed machinery on request.

The special technical documentation required for partly completed machinery has been created in accordance with Appendix VII Part B.

Person responsible for documentation is: Wolfgang Sandkötter, Benzstraße 7, 72636 Frickenhausen.

Frickenhausen, 21.08.2013



ppa. Wolfgang Sandkötter,
Chief Development Officer

12| Service

Dear customer,

GEA Bock compressors are top-quality, reliable and service-friendly quality products. If you have any questions about installation, operation and accessories, please contact our technical service or specialist wholesaler and/or our representative. The GEA Bock service team can be contacted by phone with a **toll-free hotline 00 800 / 800 000 88** or via **e-mail: refrigeration@gea.com**

Yours faithfully

GEA Bock GmbH

Benzstraße 7

72636 Frickenhausen

Germany

GB



We live our values.

Excellence • Passion • Integrity • Responsibility • GEA-versity

GEA Group is a global engineering company with multi-billion euro sales and operations in more than 50 countries. Founded in 1881, the company is one of the largest providers of innovative equipment and process technology. GEA Group is listed in the STOXX® Europe 600 index.

GEA Refrigeration Technologies

GEA Bock GmbH

Benzstraße 7, 72636 Frickenhausen, Germany
Telephone: +49 7022 9454-0, Fax: +49 7022 9454-137
refrigeration@gea.com, www.gea.com