

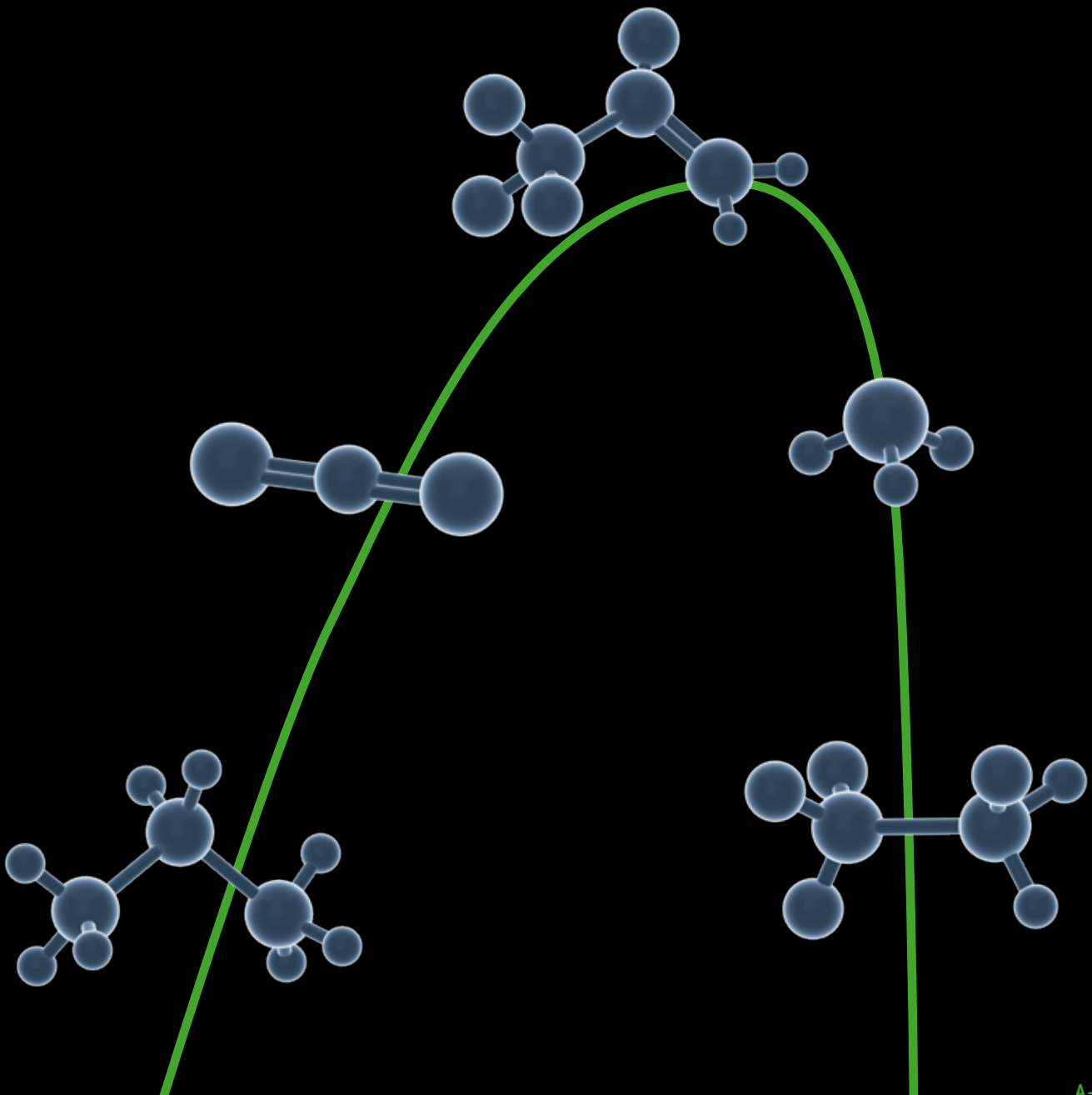













THE HEART OF FRESHNESS

# REFRIGERANT REPORT 18



Page	Contents
	 <b>Essential revisions/supplements vs. 17<sup>th</sup> edition</b>
3	 <b>General aspects on refrigerant developments</b>
3	Introduction
4	 <b>Alternative refrigerants (overview)</b>
6	<b>Environmental aspects</b>
6	Global Warming and TEWI factor
7	Eco-Efficiency
8	<b>HCFC refrigerants</b>
8	R22 as transitional refrigerant
9	<b>HFC and HFO refrigerants</b>
9	R134a as a substitute for R12 and R22 ■ Lubricants for HFCs
11	Alternatives to R134a
11	R152a – an alternative to R134a (?)
11	 "Low GWP" HFO refrigerants R1234yf and R1234ze(E)
13	<b>Refrigerant blends</b>
15	Service blends as substitutes for R502
16	Service blends as substitutes for R12 (R500)
17	<b>HFC Alternatives for R502 and R22</b>
17	 R404A and R507A as substitutes for R502 and R22
18	 R407A, R407B and R407F as substitutes for R502 and R22
19	R422A as substitute for R502 and R22
20	<b>HFC Alternatives for R22</b>
20	R407C as substitute for R22
21	R410A as substitute for R22
22	R417A, R417B, R422D and R438A as substitutes for R22
22	R427A as substitute for R22
23	 R32 as substitute for R22
24	 <b>HFO/HFC blends as alternatives to HFCs</b>
27	<b>Halogen free refrigerants</b>
27	NH <sub>3</sub> (Ammonia) as alternative refrigerant
28	R723 (NH <sub>3</sub> /DME) as an alternative to NH <sub>3</sub>
29	R290 (Propane) as substitute for R502 and R22
31	Propylene (R1270) as an alternative to Propane
32	 CO <sub>2</sub> as an alternative refrigerant and secondary fluid
36	 <b>Special applications</b>
38	 <b>Refrigerant properties</b>
40	 <b>Application ranges ■ Lubricants</b>

### Introduction

Stratospheric ozone depletion as well as atmospheric greenhouse effect due to refrigerant emissions have led to drastic changes in the refrigeration and air conditioning technology since the beginning of the 1990s.

This is especially true for the area of commercial refrigeration and A/C plants with their wide range of applications. In former years the main refrigerants used for these systems were ozone depleting types, namely R12, R22 and R502; for special applications R114, R12B1, R13B1, R13 and R503 were used.

With the exception of R22 the use of these chemicals is not allowed any more in industrialised countries. In the European Union, however, an early phase-out was already enforced in several steps (see page 8). The main reason for this early ban of R22 contrary to the international agreement is the ozone depletion potential although it is only small.

Since 2010, phase-out regulations got effective in other countries as well, in the USA for instance.

Due to this situation enormous consequences result for the whole refrigeration and air conditioning sector. BITZER therefore committed itself to taking a leading role in the research and development of environmentally benign system designs.

After the chlorine-free (ODP = 0) HFC refrigerants R134a, R404A, R407C, R507A and R410A have become widely established for many years in commercial refrigeration, air-conditioning and heat pump systems, meanwhile new challenges have come up. They concern primarily the greenhouse effect. The aim is a clear reduction of direct emissions caused by refrigerant losses and indirect emissions by particularly efficient system technology.

In this area, applicable legal regulations are already in force, such as the EU Regulation on F-Gases No. 517/2014 (see BITZER brochure A-510) and a series of regulations already ratified or in preparation as part of the EU ErP Ecodesign Directive. Similar regulations are also in preparation or have already been implemented in North America and other regions.

Even though indirect emissions caused by energy production are considerably higher than direct (CO<sub>2</sub>-equivalent) emissions caused by HFC refrigerants, refrigerants with

high global warming potential (GWP) will in future be subject to use restrictions or bans. This will affect primarily R404A and R507A, for which alternatives with lower GWP are already being offered. However, in order to achieve the legal objectives, substitutes for further refrigerants and increased use of naturally occurring substances (NH<sub>3</sub>, CO<sub>2</sub>, hydrocarbons) will become necessary.

This requires comprehensive testing of these refrigerants, suitable oils and accordingly adjusted systems.

Therefore a close co-operation exists with scientific institutions, the refrigeration and oil industries, component manufacturers as well as a number of innovative refrigeration and air conditioning companies.

A large number of development tasks have been completed. For alternative refrigerants suitable compressors are available.

Besides the development projects BITZER actively supports legal regulations and self commitments concerning the responsible use of refrigerants as well as measures to increase system and components' efficiency.

The following report deals with potential measures of a short to medium-term change towards technologies with reduced environmental impact in medium and large size commercial refrigeration and air-conditioning systems. Furthermore, the experience which exists is also dealt with and the resulting consequences for plant technology.



Several studies confirm that the vapour compression refrigeration plants normally used in the commercial field are far superior in efficiency to all other processes down to a cold space temperature of around -40°C.

The selection of an alternative refrigerant and the system design receives special significance, however. Besides the request for substances without ozone depletion potential (ODP=0) especially the energy demand of a system is seen as an essential criterion due to its indirect contribution to the greenhouse effect. On top of that there is the direct global warming potential (GWP) due to refrigerant emission.

Therefore a calculation method has been developed for the qualified evaluation of a system which enables an analysis of the total influence on the greenhouse effect.

In this connection the so-called "TEWI" factor (Total Equivalent Warming Impact) has

been introduced. Meanwhile, another, more extensive assessment method has been developed under the aspect of "Eco-Efficiency". Hereby, both ecological (such as TEWI) and economical criteria are taken into account (see also page 7).

Therefore it is possible that the assessment of refrigerants with regard to the environment can differ according to the place of installation and drive method.

Upon closer evaluation of substitutes for the originally used CFC and HCFC as well as for HFCs with higher GWP, the options with single-substance refrigerants are very limited. They include, for example, R134a, whose comparably low GWP will allow its use for a longer time to come. Furthermore this includes the hydro fluoro olefins (HFO) R1234yf and R1234ze(E) with a GWP < 10, which so far have been available to only a limited extent and for which no long-term experience is available as yet.

Direct alternatives (based on fluorinated hydrocarbons) for almost all refrigerants of higher volumetric refrigerating capacity and pressure level than R134a can only be "formulated" as blends. However, taking into account thermodynamic properties, flammability, toxicity and global warming potential, the list of potential candidates is very limited. Blends of reduced GWP include in addition to R134a, R1234yf and R1234ze(E) primarily the refrigerants R32, R125 and R152a.

Besides halogenated refrigerants, Ammonia (NH<sub>3</sub>) and hydrocarbons are considered as substitutes as well. The use for commercial applications, however, is limited by strict safety requirements.

Carbon dioxide (CO<sub>2</sub>) becomes more important as an alternative refrigerant and secondary fluid, too. Due to its specific characteristics, however, there are restrictions to a general application.

The illustrations on the next pages show a structural survey of the alternative refrigerants and a summary of the single or blended substances which are now available. After that the individual subjects are discussed.

Refrigerant properties, application ranges and lubricant specifications are shown on pages 38 to 41.

For reasons of clarity the less or only regionally known products are not specified in this issue, which is not intended to imply any inferiority.

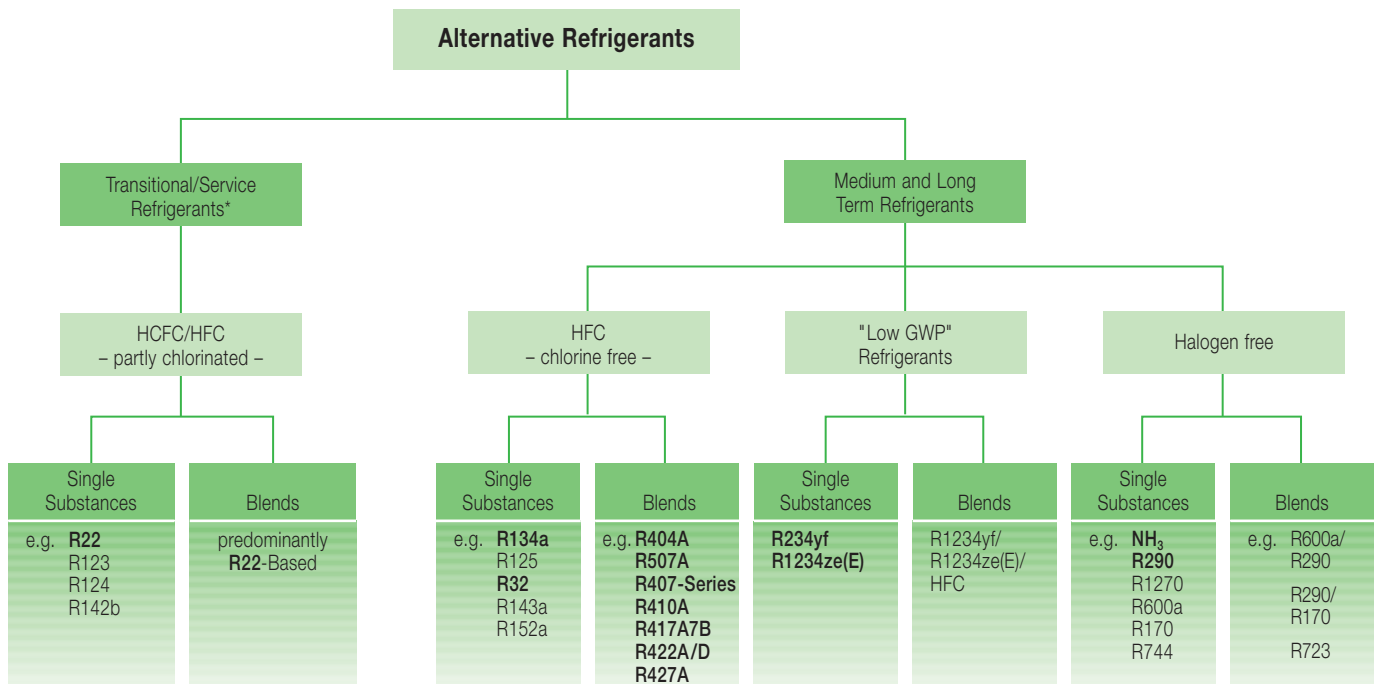

\* Service refrigerants contain HCFC as blend component. They are therefore subject to the same legal regulations as R22 (see page 8). As a result of the continued refurbishment of older installations, the importance of these refrigerants is clearly on the decline. For some of them, production has already been discontinued. However, for development-historic reasons of service blends, these refrigerants will continue to be covered in this Report.

Fig. 1 Structural classification of refrigerants

## HFC refrigerants

09.14

Former Refrigerants	Alternatives				
	ASHRAE Classification	Trade name		Composition (with blends)	Detailed Information
R12 (R500)	R134a R152a <sup>①</sup> R437A <sup>④</sup>	-	ISCEON MO49 Plus DuPont	R125/134a/600/601	pages 9...11, 16, 38...41
R502/R22	R404A R507A R422A	various various	ISCEON MO79 DuPont	R143a/R125/R134a R143a/125 R125/134a/600a	pages 17...19, 38...41
R22	R407A R407C R407F R410A R417A R417B R422D R427A R438A	various Performax LT various ISCEON MO59 Solkane 22L ISCEON MO29 Forane 427A ISCEON MO99	Mexichem, Arkema Honeywell DuPont Solvay DuPont Arkema DuPont	R32/125/134a R32/125/134a R32/125/134a R32/125 R125/134a/600 R125/134a/600 R125/134a/600a R32/125/143a/134a R32/125/134a/600/601a	pages 18...23, 38...41
R114 R12B1	R236fa R227ea	- -	- -	- -	pages 36, 38...41
R13B1	R410A -	various ISCEON MO89	DuPont	R32/125 R125/218/290	pages 37, 38...41
R13 R503	R23 R508A R508B	- KLEA 508A Suva 95	Mexichem DuPont	- R23/116 R23/116	pages 37, 38...41

Fig. 2 Substitutes for CFC and HCFC refrigerants (chlorine free HFCs)

### HFO and HFO/HFC Blends

Current Refrigerants	Alternatives				
	ASHRAE Classification	Trade name		Composition (with blends)	Detailed Information
R134a	R1234yf <sup>①</sup>	various		–	
	R1234ze(E) <sup>①</sup>	various		–	
	R513A	Opteon® XP10	DuPont	R1234yf/134a	pages 24...26 , 38...41
	R450A	Solstice N-13	Honeywell	R1234ze(E)/134a	
	–	ARM-42 <sup>①</sup>	Arkema	R1234yf/152a/134a	
–	AC5X	Mexichem	R32/1234ze(E)/134a		
R404A/R507A*	R449A	Opteon® XP40	DuPont	R32/125/1234yf/134a	
	R448A	Solstice N-40	Honeywell	R32/125/1234yf/1234ze(E)/134a	pages 24...26 , 38...41
	–	ARM-32b	Arkema	not disclosed	
–	LTR4X	Mexichem	R32/125/1234ze(E)/134a		
R22/R407C*	–	DR-91	DuPont	not disclosed	
	–	Solstice N-20	Honeywell	R32/125/1234yf/1234ze(E)/134a	pages 24...26
	–	ARM-32c	Arkema	not disclosed	
R410A	R32 <sup>①</sup>	various		–	
	–	Opteon® XL41 <sup>①</sup>	DuPont	R32/1234yf	
	R447A <sup>①</sup>	Solstice L-41 <sup>①</sup>	Honeywell	R32/125/1234ze(E)	pages 24...26
	–	ARM-71a <sup>①</sup>	Arkema	not disclosed	
–	HPR1D <sup>①</sup>	Mexichem	R32/1234ze(E)/CO <sub>2</sub>		

\* Due to the large number of different HFO/HFC blends and the potential changes in development products, the above list for R404A/R507A and R22/R407C alternatives only contains **non-flammable** blends of GWP < 1500. On pages 24 to 26, HFO/HFC blends are extensively discussed. Further options are also dealt with.

Fig. 3 "Low GWP" Refrigerants and blends

### Halogen free refrigerants

09.14

Current Refrigerants	Alternatives			
	ASHRAE Classification	Trade name	Formula	Detailed Information
R134a	R290/600a <sup>①</sup>	–	C <sub>3</sub> H <sub>8</sub> /C <sub>4</sub> H <sub>10</sub>	pages 29, 38...41
	R600a <sup>①③</sup>	–	C <sub>4</sub> H <sub>10</sub>	
R404A R507A R22	R717 <sup>①②</sup>	–	NH <sub>3</sub>	
	R723 <sup>①②⑤</sup>	–	NH <sub>3</sub> + R-E170	pages 27...31, 38...41
	R290 <sup>①</sup>	–	C <sub>3</sub> H <sub>8</sub>	
	R1270 <sup>①</sup>	–	C <sub>3</sub> H <sub>6</sub>	
R124	R600a <sup>①</sup>	–	C <sub>4</sub> H <sub>10</sub>	pages 36, 38...41
R410A M089	no direct alternatives available			
R23	R170 <sup>①</sup>	–	C <sub>2</sub> H <sub>6</sub>	pages 37, 38...41
Various	R744 <sup>③</sup>			pages 32...35, 38...41

Fig. 4 Alternatives for HCFC and HFC refrigerants (halogen free refrigerants)

Explanation of Fig. 2 to 4

① Flammable  
② Toxic

③ Large deviation in refrigerating capacity and pressures to the previous refrigerant

④ Service refrigerant with zero ODP

⑤ Azeotrope

## Global Warming and TEWI Factor

As already mentioned in the introduction a method of calculation has been developed, with which the influence upon the global warming effect can be judged for the operation of individual refrigeration plants (TEWI = Total Equivalent Warming Impact).

All halocarbon refrigerants, including the non-chlorinated HFCs belong to the category of the greenhouse gases. An emission of these substances contributes to the global warming effect. The influence is however much greater in comparison to CO<sub>2</sub> which is the main greenhouse gas in the atmosphere (in addition to water vapour). Based on a time horizon of 100 years, the emission from 1 kg R134a is for example roughly equivalent to 1430 kg of CO<sub>2</sub> (GWP<sub>100</sub> = 1430).

It is already apparent from these facts that the reduction of refrigerant losses must be one of the main tasks for the future.

On the other hand, the major contributor to a refrigeration plant's global warming effect is the (indirect) CO<sub>2</sub> emission caused by energy generation. Based on the high percentage of fossil fuels used in power stations the average European CO<sub>2</sub> release is around 0.45 kg per kWh of electrical energy. A significant greenhouse effect occurs over the lifetime of the plant as a result of this.

As this is a high proportion of the total balance it is also necessary to place an increased emphasis upon the **use of high efficiency compressors** and associated equipment as well as optimized system components, in addition to the demand for alternative refrigerants with favourable (thermodynamic) energy consumption.

When various compressor designs are compared, the difference of indirect CO<sub>2</sub> emission (due to the energy requirement) can have a larger influence upon the total effect as the refrigerant losses.

A usual formula is shown in Fig. 5, the TEWI factor can be calculated and the various areas of influence are correspondingly separated.

In addition to this an example in Fig. 6 (medium temperature with R134a) shows the influence upon the TEWI value with vari-

ous refrigerant charges, leakage losses and energy consumptions.

This example is simplified based on an overall leak rate as a percentage of the refrigerant charge. As is known the practical values vary very strongly whereby the potential risk with individually constructed systems and extensively branched plants is especially high.

Great effort is taken worldwide to reduce greenhouse gas emissions and legal regulations have partly been developed already. Since 2007, the "Regulation on certain fluorinated greenhouse gases" – which also defines stringent requirements for refrigeration and air-conditioning systems – has become valid for the EU. Meanwhile, the revised Regulation No. 517/2014 entered into force and will become applicable as of January 2015.

**TEWI = TOTAL EQUIVALENT WARMING IMPACT**

$$TEWI = (GWP \times L \times n) + (GWP \times m [1 - \alpha_{\text{recovery}}]) + (n \times E_{\text{annual}} \times \beta)$$

← Leakage →
← Recovery losses →
← Energy consumption →

← direct global warming potential →
← indirect global warming potential →

GWP	= Global warming potential	[ CO <sub>2</sub> -related acc. to IPCC IV ]
L	= Leakage rate per year	[ kg ]
n	= System operating time	[ Years ]
m	= Refrigerant charge	[ kg ]
α <sub>recovery</sub>	= Recycling factor	
E <sub>annual</sub>	= Energy consumption per year	[ kWh ]
β	= CO <sub>2</sub> -Emission per kWh	(Energy-Mix)

Fig. 5 Method for the calculation of TEWI figures

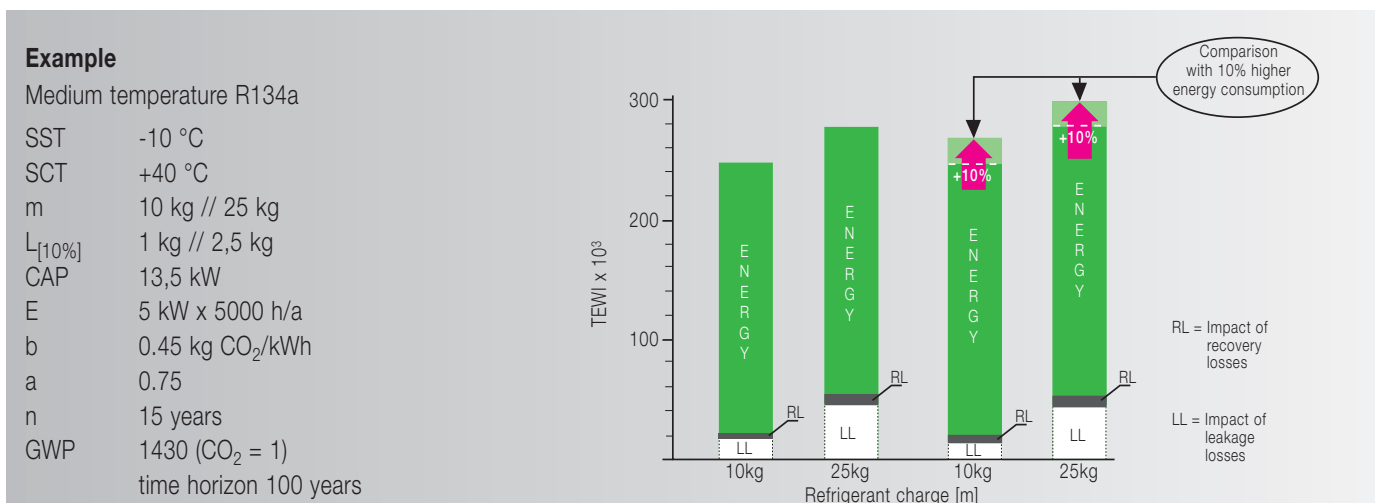

Fig. 6 Comparison of TEWI figures (example)



### Eco-Efficiency

As mentioned above, an assessment based on the specific TEWI value takes into account the effects of global warming during the operating period of a refrigeration, air-conditioning or heat pump installation. Hereby, however, the entire ecological and economical aspects are not considered.

But apart from ecological aspects, when evaluating technologies and making investment decisions, economical aspects are highly significant. With technical systems, the reduction of environmental impact frequently involves high costs, whereas low costs often have increased ecological consequences. For most companies, the investment costs are decisive, whereas they are often neglected during discussions about minimizing ecological problems.

For the purpose of a more objective assessment, studies\* were presented in 2005 and 2010, using the example of supermarket refrigeration plants to describe a concept for evaluating **Eco-Efficiency**. It is based on the relationship between added value (a product's economic value) and the resulting environmental impact.

With this evaluation approach, the entire life cycle of a system is taken into account in terms of:

- ❑ ecological performance in accordance with the concept of Life Cycle Assessment as per ISO 14040,
- ❑ economic performance by means of a Life Cycle Cost Analysis.

This means that the overall environmental impact (including direct and indirect emissions), as well as the investment costs, operating and disposal costs, and capital costs are taken into account.

The studies also confirm that an increase of Eco-Efficiency can be achieved by investing in optimized plant equipment (minimized operating costs). Hereby, the choice of refrigerant and the associated system technology plays an important role.

Eco-Efficiency can be illustrated in graphic representation (see example in Fig. 8). For this, the results of the Eco-Efficiency evaluation are shown on the x-axis in the system of coordinates, whilst the results of the life cycle cost analysis are shown on the y-axis. This representation shows clearly that a system exhibits an increasingly better Eco-

Efficiency, the higher it lies in the top right quadrant – and conversely, it becomes less efficient in the bottom left sector.

The diagonals plotted into the system of coordinates represent lines of equal Eco-Efficiency. This means that systems or processes with different life cycle costs and environmental impacts can quite possibly exhibit the same Eco-Efficiency.

\* Study 2005: Compiled by Solvay Management Support GmbH and Solvay Fluor GmbH, Hannover, together with the Information Centre on Heat Pumps and Refrigeration (IZW), Hannover.

Study 2010: Compiled by SKM ENVIROS, UK, commissioned by and in cooperation with EPEE (European Partnership for Energy and Environment).

Both projects were supported by an advisory group of experts from the refrigeration industry.

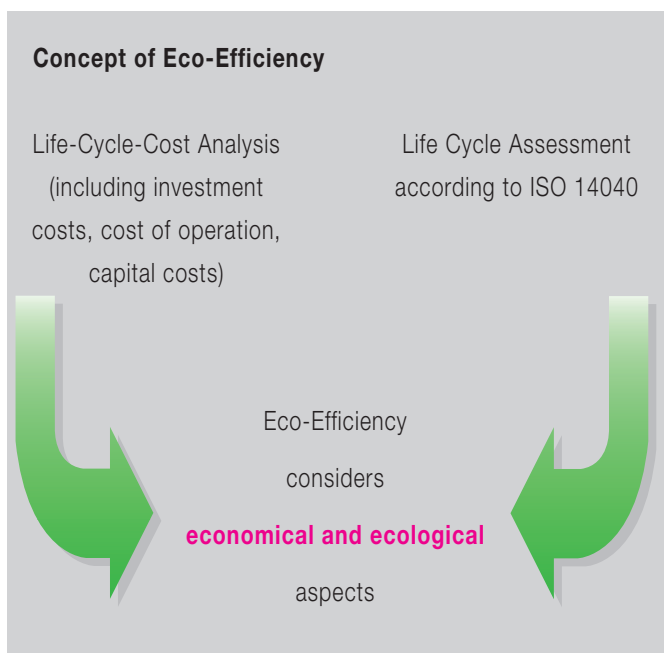

Fig. 7 Concept of Eco-Efficiency

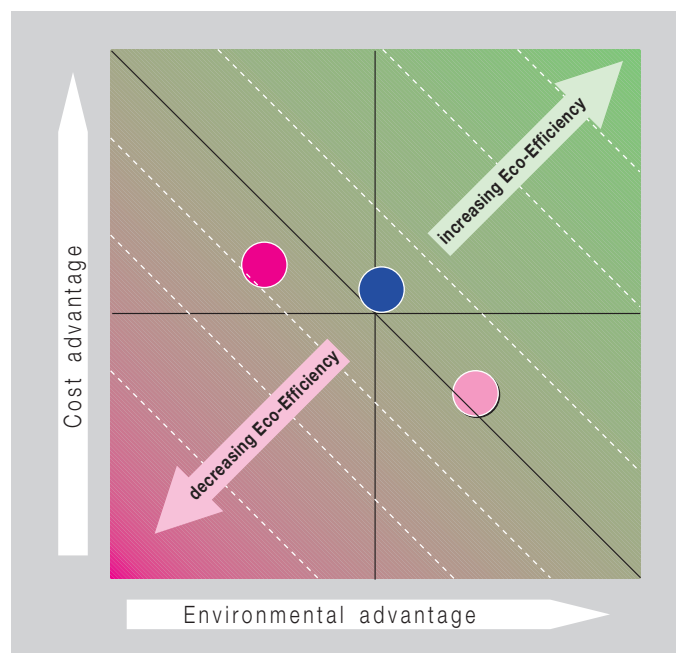

Fig. 8 Example of an Eco-Efficiency evaluation

## R22 as transitional refrigerant

Although chlorine free substitutes like R134a and R404A/R507A (Figs. 1 and 2) have extensively made their way as substitutes, in many international fields R22 is still used in new installations and for retrofitting of existing systems.

Reasons are relatively low investment costs, especially compared with R134a systems, but also in its large application range, favourable thermodynamic properties and low energy requirement. Additionally there is world wide availability of R22 and the proven components for it, which is not yet guaranteed everywhere with the chlorine free alternatives.

Despite of the generally favourable properties R22 is already subject to various regional restrictions\* which control the use of this refrigerant in new systems and for service purposes due to its ozone depletion potential – although being low.

With regard to components and system technology a number of particularities are to follow as well. Refrigerant R22 has approximately 55% higher refrigerating capacity and pressure levels in comparison to R12\*\*. The significantly higher discharge gas temperature is also a critical factor compared to R12 (Fig. 9) and R502\*\*.

Similar relationships in terms of thermal load are found in the comparison with HFC refrigerants R134a, R404A/R507A (pages 9 and 17).

### Resulting design criteria

Particularly critical – due to the high discharge gas temperature – are low temperature plants especially concerning thermal stability of oil and refrigerant, with the danger of acid formation and copper plating. Special measures have to be adopted therefore, such as two stage compression, controlled refrigerant injection, additional cooling, monitoring of discharge gas temperature, limiting the suction gas superheat and particularly careful installation.

**BITZER can supply a widespread range of reciprocating, screw and scroll compressors for R22.**

\* Not allowed for new equipment in Germany and Denmark since January 1<sup>st</sup>, 2000 and in Sweden as of 1998.

Since January 1<sup>st</sup>, 2001 restrictions apply to the other member states of the EU as well. The measures concerned are defined in the ODS Regulation 1005/2009 of the EU commission on ozone depleting substances amended in 2009. This regulation also governs the use of R22 for service reasons within the entire EU.

Since 2010, phase-out regulations in other countries, such as the USA, are valid.

\*\* Already banned in most countries.

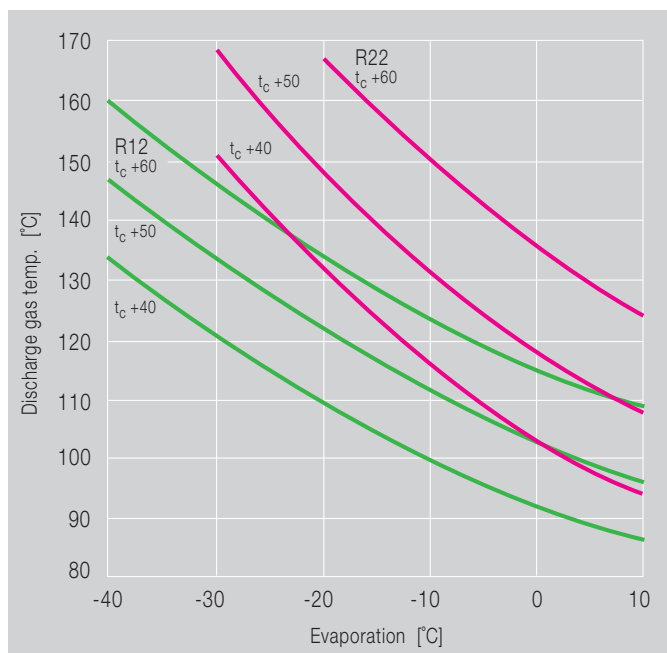

Fig. 9 R12/R22 – comparison of discharge gas temperatures of a semi-hermetic compressor

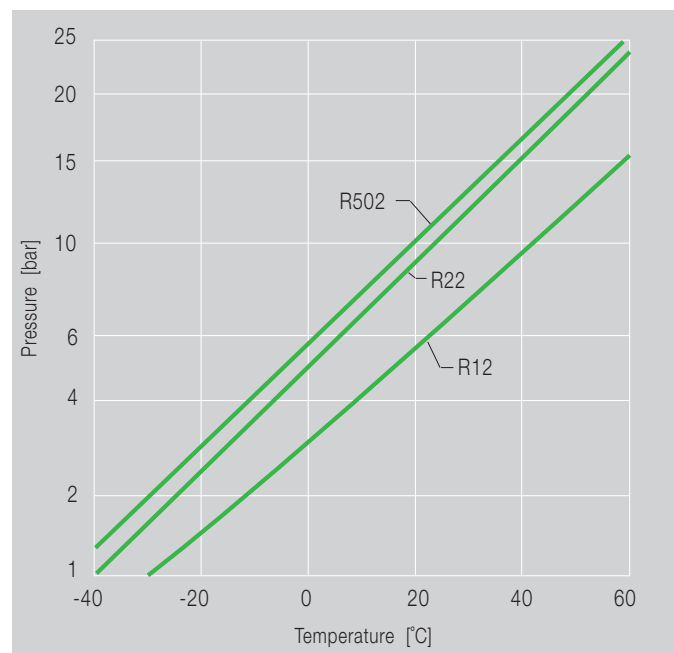

Fig. 10 R12/R22/R502 – comparison of pressure levels



### R134a as substitute for R12 and R22

R134a was the first chlorine free (ODP = 0) HFC refrigerant that was tested comprehensively. It is now used world-wide in many refrigeration and air-conditioning units with good results. As well as being used as a pure substance R134a is also applied as a component of a variety of blends (see "Refrigerant blends", from page 13).

#### R134a has similar thermodynamic properties to R12:

Refrigerating capacity, energy demand, temperature properties and pressure levels are comparable, at least in air-conditioning and medium temperature refrigeration plants. This refrigerant can therefore be used as an alternative for most former R12 applications.

For some applications **R134a is even preferred as a substitute for R22**, an important reason being the limitations to the use of R22 in new plants and for service. However, the lower volumetric refrigerating capacity of R134a (see Fig. 11/2) requires a larger compressor displacement than with

R22. There are also limitations in the application with low evaporating temperatures to be considered.

Comprehensive tests have demonstrated that the performance of R134a exceeds theoretical predictions over a wide range of compressor operating conditions. Temperature levels (discharge gas, oil) are even lower than with R12 and, therefore, substantially lower than R22 values. There are thus many potential applications in air-conditioning and medium temperature refrigeration plants as well as in heat pumps. Good heat transfer characteristics in evaporators and condensers (unlike zeotropic blends) favour particularly an economical use.

R134a is also characterized by a comparably low GWP (1430). In view of future use restrictions (e.g. EU F-Gas Regulation), this refrigerant will continue to be applicable for a longer time to come.

#### Lubricants for R134a and other HFCs

The traditional mineral and synthetic oils are not miscible (soluble) with R134a and other HFCs described in the following and are therefore only insufficiently transported around the refrigeration circuit. Immiscible oil can settle out in the heat exchangers and prevent heat transfer to such an extent that the plant can no longer be operated. New lubricants were developed with the appropriate solubility and have been in use for many years. These lubricants are based on Polyol Ester (POE) and Polyalkylene Glycol (PAG).

They have similar lubrication characteristics to the traditional oils, but are more or less hygroscopic, dependent upon the refrigerant solubility.

This demands special care during manufacturing (including dehydrating), transport, storage and charging, to avoid chemical reactions in the plant, such as hydrolysis.

PAG based oils are especially critical with respect to water absorption. Moreover, they have a relatively low dielectric strength and for this reason are not very suitable for semi-hermetic and hermetic compressors. They are therefore mainly used in car A/C

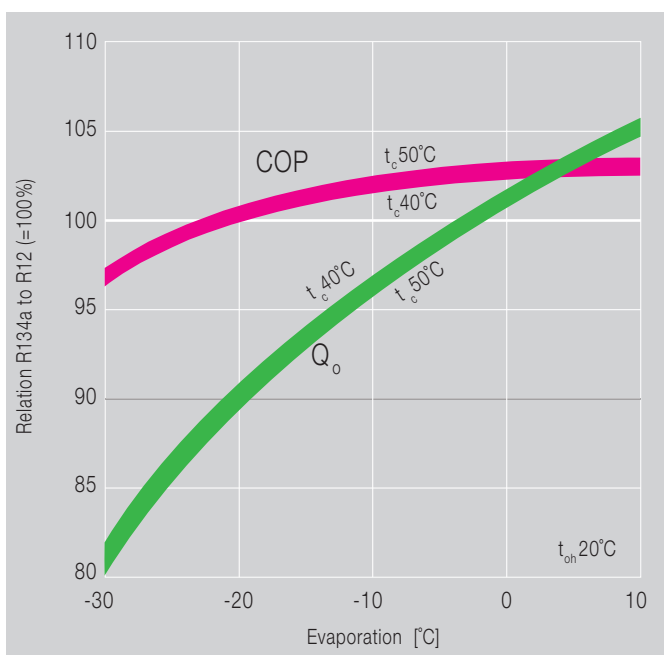

Fig. 11/1 R134a/R12 – comparison of performance data of a semi-hermetic compressor

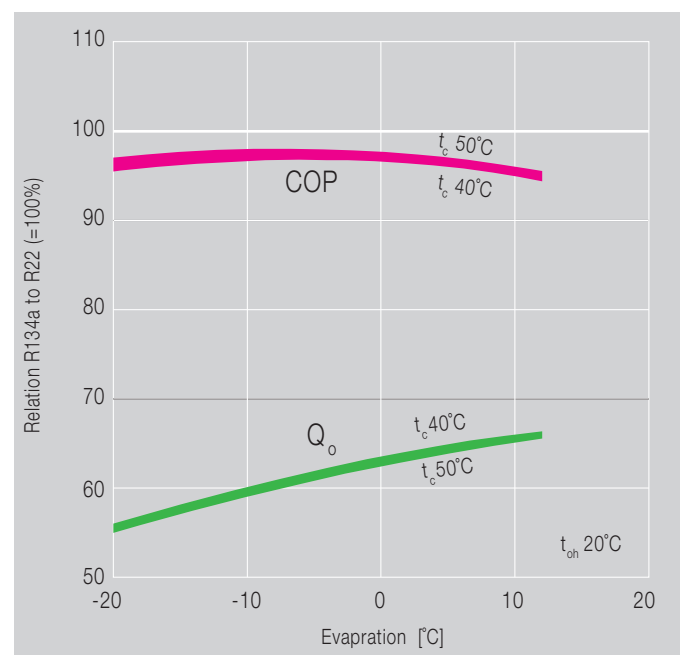

Fig. 11/2 R134a/R22 – comparison of performance data of a semi-hermetic compressor

systems with open compressors, where specific demands are placed on lubrication and optimum solubility is required because of the high oil circulation rate. In order to avoid copper plating, no copper containing materials are used in these systems either. The rest of the refrigeration industry prefers **ester oils**, for which extensive experience is already available. The results are positive when the water content in the oil does not much exceed 100 ppm.

Compressors for factory made A/C and cooling units are increasingly being charged with **Polyvinyl Ether (PVE) oils**. Although they are even more hygroscopic than POE, on the other hand they are very resistant to hydrolysis, thermally and chemically stable, possess good lubricating properties and high dielectric strength. Unlike POE they do not tend to form metal soap and thus the danger of capillary clogging is reduced.

### Resulting design and construction criteria

Suitable compressors are required for R134a with a special oil charge, and adapted system components.

The normal metallic materials used in CFC plants have also been proven with ester oils; elastomers must sometimes be matched to the changing situation. This is especially valid for flexible hoses where the requirements call for a minimum residual moisture content and low permeability.

The plants must be dehydrated with particular care and the charging or changing of lubricant must also be done carefully. In addition relatively large driers should be provided, which have also to be matched to the smaller molecule size of R134a.

**Meanwhile, many years of very positive experience with R134a and ester oils have been accumulated. For this refrigerant, BITZER offers an unequalled wide range of reciprocating, screw, and scroll compressors.**

### Converting existing R12 plants

At the beginning this subject had been discussed very controversially, several conversion methods were recommended and applied. Today there is a general agreement on technically and economically matching solutions.

Here, the characteristics of ester oils are very favourable. Under certain conditions they can be used with CFC refrigerants, they can be mixed with mineral oils and tolerate a proportion of chlorine up to a few hundred ppm in an R134a system.

The remaining moisture content has, however, an enormous influence. The essential requirement therefore exists for very thorough evacuation (removal of remaining chlorine and dehydration) and the installation of generously dimensioned driers. Doubtful experience has been found, with systems where the chemical stability was already insufficient with R12 operation e.g. with bad maintenance, small drier capacity, high thermal loading. The increased deposition of oil decomposition products containing chlorine often occurs here. These products are released by the working of the highly polarized mixture of ester oil and R134a and find their way into the compressor and regulating devices. Conversion should therefore be limited to systems which are in a good condition.

### Restrictions for R134a in mobile air-conditioning (MAC) systems

In future, a new EU Directive on "Emissions from MAC systems" will ban the use of R134a in new systems. Several alternative technologies are already being developed. See the pertaining explanations on pages 11, 12 and 35.

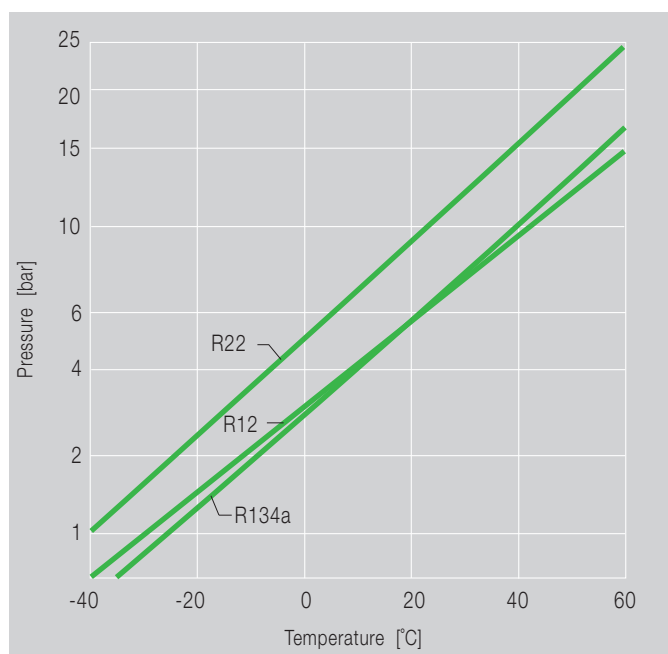

Fig. 12 R134a/R12/R22 – comparison of pressure levels

### Supplementary BITZER information concerning the use of R134a (see also <http://www.bitzer.de>)

- Semi-hermetic reciprocating compressors KP-104 "ECOLINE Series"
- Technical Information KT-620 "HFC Refrigerant R134a"
- Technical Information KT-510 "Polyolester oils for reciprocating compressors"
- Special edition "A new generation of compact screw compressors optimised for R134a"

## Alternatives to R134a

For mobile air-conditioning systems (MAC) with open drive compressors and hose connections in the refrigerant circuit, the risk of leakages is considerably higher than with stationary systems. With a view to reducing direct emissions in this application area, an EU Directive (2006/40/EC) has therefore been passed. Within the scope of the Directive, and starting 2011, type approvals for new vehicles will only be granted if they use refrigerants with a global warming potential (GWP) of less than 150. Consequently, this excludes R134a (GWP = 1430) which has been used so far in these systems.

Meanwhile, alternative refrigerants and new technologies were developed and tested. This also involved a closer examination of the use of R152a.

For quite some time the automotive industry has agreed on so-called "Low GWP" refrigerants. The latter is dealt with as follows.

The CO<sub>2</sub> technology which was preferred for this type of application for a long time has not yet been introduced for different reasons (see pages 12 and 35).

## R152a – an alternative to R134a (?)

Compared to R134a, R152a is very similar with regard to volumetric cooling capacity (approx. -5%), pressure levels (approx. -10%) and energy efficiency. Mass flow, vapour density and thus also the pressure drop are even more favourable (approx. -40%).

R152a has been used for many years as a component in blends but not as a single substance refrigerant till now. Especially advantageous is the very low global warming potential (GWP = 124).

R152a is flammable – due to its low fluorine content – and classified in safety group A2. As a result, increased safety requirements demand individual design solutions and safety measures along with the corresponding risk analysis.

For this reason, the use of R152a in MAC systems is rather unlikely.

## "Low GWP" HFO refrigerants R1234yf and R1234ze(E)

The ban on the use of R134a in mobile air-conditioning systems within the EU has triggered a series of research projects. Apart from the CO<sub>2</sub> technology (page 35), new refrigerants with very low GWP values and similar thermodynamic properties as R134a have been developed.

In early 2006, two refrigerant mixtures were introduced under the names "Blend H" (Honeywell) and "DP-1" (DuPont). INEOS Fluor followed with another version under the trade name AC-1. In the broadest sense, all of these refrigerants were blends of various fluorinated molecules.

During the development and test phase it became obvious that not all acceptance criteria could be met, and thus further examinations with these blends were discontinued. Consequently, DuPont\* and Honeywell\* bundled their research and development activities in a joint venture which focused on 2,3,3,3-tetrafluoropropene (CF<sub>3</sub>CF = CH<sub>2</sub>). This refrigerant, designated R1234yf, belongs to the group of hydro fluoro olefins (HFO). These refrigerants are unsaturated HFCs with a chemical double bond.

The global warming potential is extremely low (GWP<sub>100</sub> = 4). When released to the atmosphere, the molecule rapidly disintegrates within a few days, resulting in a very low GWP. This raises certain concerns regarding the long-term stability in refrigeration circuits under real conditions. However, extensive testing has demonstrated the required stability for mobile air-conditioning systems.

R1234yf is mildly flammable as measured by ASTM 681, but requires significantly more ignition energy than R152a, for instance. Due to its low burning velocity and the high ignition force, it received a classification of the new safety group "A2L" according to ISO 817.

In extensive test series, it has been shown that a potentially increased risk of the refrigerant flammability in MAC systems can be avoided by implementing suitable con-

structive measures. However, some investigations (e.g. by Daimler-Benz) also show an increased risk. This is why various manufacturers have intensified again the development of alternative technologies.

Toxicity investigations have shown very positive results, as well as compatibility tests of the plastic and elastomer materials used in the refrigeration circuit. Some lubricants show increased chemical reactivity which, however, can be suppressed by a suitable formulation and/or addition of "stabilizers".

Operating experiences gained from laboratory and field trials to date allow a positive assessment, particularly with regard to performance and efficiency behaviour. For the usual range of mobile air-conditioning operation, refrigerating capacity and coefficient of performance (COP) are within a range of 5% compared with that of R134a. Therefore, it is expected that simple system modifications will provide the same performance and efficiency as with R134a.

The critical temperature and pressure levels are also similar, while the vapour densities and mass flows are approximately 20% higher. The discharge gas temperature with this application is up to 10 K lower.

With a view to the relatively simple conversion of mobile air-conditioning systems, this technology prevailed up to now over the competing CO<sub>2</sub> systems.

However, as already explained before, due to the flammability of R1234yf, investigations focus on other technical solutions. They include, among others, CO<sub>2</sub> systems.

### **Further applications for HFO refrigerants**

The use of R1234yf in other mobile air-conditioning applications is also being considered, as well as in stationary A/C and heat pump systems. However, this must take into account the charge limitations for the A2(L) refrigerants (e.g. EN378), which will restrict their use accordingly. Additional concerns are those regarding the long-term stability in refrigeration circuits, given the usually very long life cycles of such systems.

For applications requiring the use of refrigerants of safety group A1 (neither flammable nor toxic), R134a alternatives of lower GWP based on HFO/HFC blends have already been developed. They have been tested for some time in real systems.

R1234yf, as well as R1234ze(E), described below, are also used as base components in HFO/HFC blends. In view of legal regulations for the reduction of F-Gas emissions (e.g. EU F-Gas Regulation), these blends have been developed as "Low GWP" alternatives to R404A/R507, R22/R407C and R410A. Some of these refrigerants have already been tested with regard to refrigerating capacity and efficiency as parts of the "Alternative Refrigerants Evaluation Program" (AREP) initiated by AHRI and have also been used in trial systems. For further information on HFO/HFC blends, see page 24.

From the group of hydro fluoro olefins, another substance under the name R1234ze(E) is available, which until now has been used predominantly as blowing agent for polyurethane foam and propellant. R1234ze(E) differs from R1234yf by having a different molecular structure. Its thermodynamic properties also provide favourable conditions for the use as refrigerant. Its global warming potential is also very low (GWP<sub>100</sub> = 7).

Often there is a degree of uncertainty concerning flammability. In safety data sheets, R1234ze(E) is declared as non-flammable. However, this only applies to transport and storage. When used as a refrigerant, a higher reference temperature of 60°C for flammability tests is valid. At this temperature, R1234ze(E) is flammable and therefore classified in the same safety group A2L as R1234yf.

R1234ze(E) is sometimes called an R134a substitute, but its volumetric refrigerating capacity is more than 20% below that of R134a or R1234yf. Moreover, the boiling point (-18°C) considerably limits its use for lower evaporation temperatures. Therefore, the preferred use of positive displacement compressors is for high temperature applications. For further information, see page 36, "Special applications".

## Refrigerant blends

Refrigerant blends have been developed for existing as well as for new plants with properties making them comparable alternatives to the previously used substances.

It is necessary to distinguish between three categories:

### 1. Transitional or service blends

Most of these blends contain HCFC R22 as the main constituent. They are primarily intended as **service refrigerants for older plants** with view on the use ban of R12, R502 and other CFCs.

Corresponding products are offered by various manufacturers, the practical experience covering the necessary steps of conversion procedure are available.

However, the same legal requirements apply for the use and phase-out regulations of these blends as for R22 (see page 8).

### 2. HFC blends

These are substitutes for the refrigerants R502, R22, R13B1 and R503. Above all, R404A, R507A, R407C and R410A, are being used to a great extent.

One group of these HFC blends also contains hydrocarbon additives. The latter exhibit an improved solubility with lubricants, and under certain conditions they allow the use of conventional oils. In many cases, this opens up possibilities for the conversion of existing (H)CFC plants to chlorine-free refrigerants (ODP = 0) without the need for an oil change.

### 3. HFO/HFC blends

as successor generation of HFC refrigerants. It concerns blends of new "Low GWP" refrigerants (e.g. R1234yf) with HFCs. The fundamental target is an additional decrease of the global warming potential (GWP) as compared to established halogenated substances (see page 24).

Two and three component blends already have a long history in the refrigeration trade.

A difference is made between the so called "azeotropes" (e.g. R502, R507A) with thermodynamic properties similar to single substance refrigerants, and "zeotropes" with "gliding" phase changes (see also next section). The original development of "zeotropes" was mainly concentrated on special applications in low temperature and heat pump systems. Actual system construction remained, however, the exception.

A somewhat more common earlier practice was the mixing of R12 to R22 in order to improve the oil return and to reduce the discharge gas temperature with higher pressure ratios. It was also usual to add R22 to R12 systems for improved performance, or to add hydrocarbons in the extra low temperature range for a better oil transport.

This possibility of specific "formulation" of certain characteristics was indeed the basis for the development of a new generation of blends.

In section "Introduction" (page 3), it was already explained that no direct single-substance alternatives (on the basis of fluorinated hydrocarbons) exist for the previously used and current refrigerants of higher volumetric refrigeration capacity than R134a. This is why they can only be "formulated" as blends. However, taking into account thermodynamic properties, flammability, toxicity and global warming potential, the list of potential candidates is strongly limited.

For the previously developed CFC and HCFC substitutes, the range of substances was still comparably large, due to the fact that substances of high GWP could also be used. However, for formulating blends with significantly reduced GWP, in addition to R134a, R1234yf and R1234ze(E), primarily refrigerants R32, R125 and R152a can be used. Most of them are flammable. They also exhibit considerable differences with respect to their boiling points, which is why all "Low GWP" blends of high volumetric refrigerating capacity have a substantial temperature glide (see following section).

**BITZER has accumulated extensive experience with refrigerant blends. Laboratory and field testing was commenced at an early stage so that basic information was obtained for the optimizing of the mixing proportions and for testing suitable lubricants. Based on this data, a large supermarket plant – with 4 BITZER semi-hermetics in parallel – could already be commissioned in 1991.**

**The use of these blends in the most varied systems has been state-of-the-art for many years – generally with good experiences.**

### General characteristics of zeotropic blends

As opposed to azeotropic blends (e.g. R502, R507A), which behave as single substance refrigerants with regard to evaporation and condensing processes, the phase change with zeotropic fluids occurs in a "gliding" form over a certain range of temperature.

This "temperature glide" can be more or less pronounced, it is mainly dependent upon the boiling points and the percentage proportions of the individual components. Certain supplementary definitions are also being used, depending on the effective values, such as "near-azeotrope" or "semi-azeotrope" for less than 1 K glide.

This means in practice already a small increase in temperature in the evaporation phase and a reduction during condensing. In other words, based on a certain pressure the resulting saturation temperatures differ in the liquid and vapour phases (Fig. 13).

To enable a comparison with single substance refrigerants, the evaporating and condensing temperatures have been often defined as mean values. As a consequence the measured subcooling and superheating conditions (based on mean values) are unreal. The effective result – related to dew and bubble temperature – is less in each case.



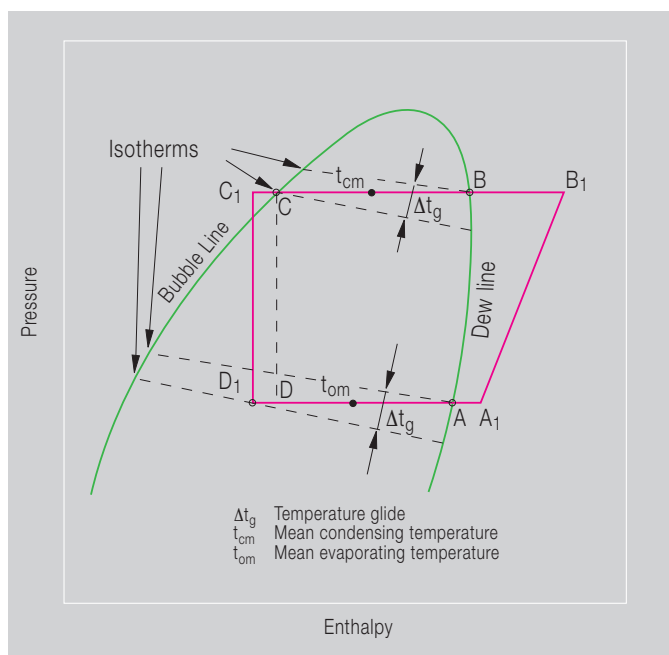

**Fig. 13** Evaporating and condensing behavior of zeotropic blends

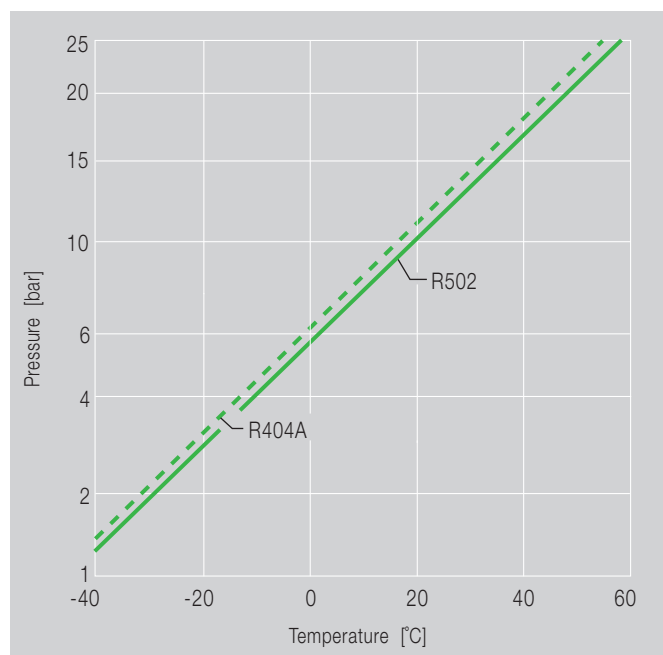

**Fig. 14** Pressure level of R404A in comparison to R502

These factors are very important when assessing the minimum superheat at the compressor inlet (usually 5 to 7 K) and the quality of the refrigerant after the liquid receiver.

With regard to a uniform and easily comprehensible definition of the rated compressor capacity, the revised standards EN12900 and AHRI540 are applied. Evaporating and condensing temperatures refer to saturated conditions (dew points).

- Evaporating temperature according to point A (Fig. 13).
- Condensing temperature according to point B (Fig. 13).

In this case the assessment of the effective superheat and subcooling temperatures will be simplified.

It must however be considered that the actual refrigerating capacity of the system can be higher than the rated compressor capacity. This is partly due to an effectively lower temperature at the evaporator inlet.

A further characteristic of zeotropic refrigerants is the potential concentration shift when leakage occurs. Refrigerant loss in the pure gas and liquid phases is mainly non-critical. Leaks in the phase change areas, e.g. after the expansion valve, within the evaporator and condenser/receiver are considered more significant.

It is therefore recommended that soldered or welded joints should be used in these sections.

Extended investigations have in the meantime shown that the effect of leakage leads to less serious changes in concentration than was initially thought. It is in any case certain that the following substances of safety group A1 (see page 38) which are dealt with here cannot develop any flammable mixtures, either inside or outside the circuit. Essentially similar operating conditions and temperatures as before can only be obtained by supplementary charging with the original refrigerant in the case of a small temperature glide.

Further conditions/recommendations concerning the practical handling of blends must also be considered:

- The plant always has to be charged with liquid refrigerant. When vapour is taken from the charging cylinder shifts in concentrations may occur.
- Since all blends contain at least one flammable component, the entry of air into the system must be avoided. A critical shift of the ignition point can occur under high pressure and evacuating when a high proportion of air is present.
- The use of blends with a significant temperature glide is not recommended for plants with flooded evaporators. A large concentration shift is to be expected in this type of evaporator, and as a result also in the circulating refrigerant mass flow.



### Service blends with the basic component R22\* as substitutes for R502

As a result of the continued refurbishment of older installations, the importance of these refrigerants is clearly on the decline. For some of them, production has already been discontinued. However, for development-historic reasons of service blends, these refrigerants will continue to be covered in this Report.

These refrigerants belong to the group of "Service blends" and are offered under the designations R402A/R402B\* (HP80/ HP81 – DuPont), R403A/R403B\* (formerly ISCEON 69S/69L) and R408A\* ("Forane" FX10 – Arkema).

The basic component is in each case R22, the high discharge gas temperature of which is significantly reduced by the addition of chlorine free substances with low isentropic compression exponent (e.g. R125, R143a, R218). A characteristic feature of these additives is an extraordinarily high mass flow, which enables the mixture to achieve a great similarity to R502.

R290 (Propane) is added as the third component to R402A/B and R403A/B to improve

miscibility with traditional lubricants as hydrocarbons have especially good solubility characteristics.

For these blends two variations are offered in each case. When optimizing the blend variations with regard to identical refrigerating capacity as for R502 the laboratory measurements showed a significantly increased discharge gas temperature (Fig. 15), which above all, with higher suction gas superheat (e.g. supermarket use) leads to limitations in the application range.

On the other hand a higher proportion of R125 or R218, which has the effect of reducing the discharge gas temperature to the level of R502, results in somewhat higher cooling capacity (Fig. 16).

With regard to material compatibility the blends can be judged similarly to (H)CFC refrigerants. The use of conventional refrigeration oil (preferably semi or full synthetic) is also possible due to the R22 and R290 proportions.

Apart from the positive aspects there are also some disadvantages. These substances can also only be seen as alternatives for a limited time. The R22 proportion has (although low) an ozone depletion potential. The additional components R125,

R143a and R218 still have a high global warming potential (GWP).

### Resulting design criteria/ Converting existing R502 plants

The compressor and the components which are matched to R502 can remain in the system in most cases. The limitations in the application range must however be considered: Higher discharge gas temperature as for R502 with R402B\*\*, R403A\*\* and R408A\*\* or higher pressure levels with R402A\*\* and R403B\*\*.

Due to the good solubility characteristics of R22 and R290 an increased danger exists, that after conversion of the plant, possible deposits of oil decomposition products containing chlorine may be dissolved and find their way into the compressor and regulating devices. Systems where the chemical stability was already insufficient with R502 operation (bad maintenance, low drier capacity, high thermal loading) are particularly at risk.

\* When using blends containing R22 legal regulations are to be observed, see also page 8.

\*\* Classification according to ASHRAE nomenclature.

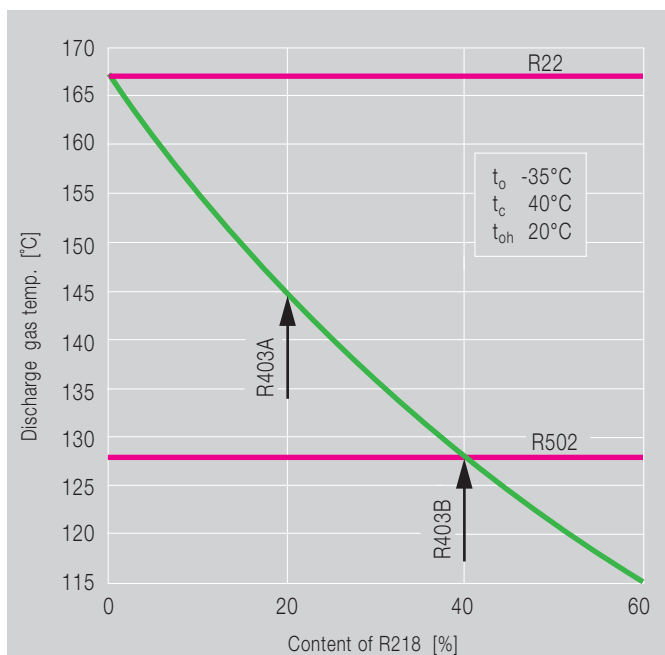

Fig. 15 Effect of the mixture variation upon the discharge gas temperature (example: R22/R218/R290)

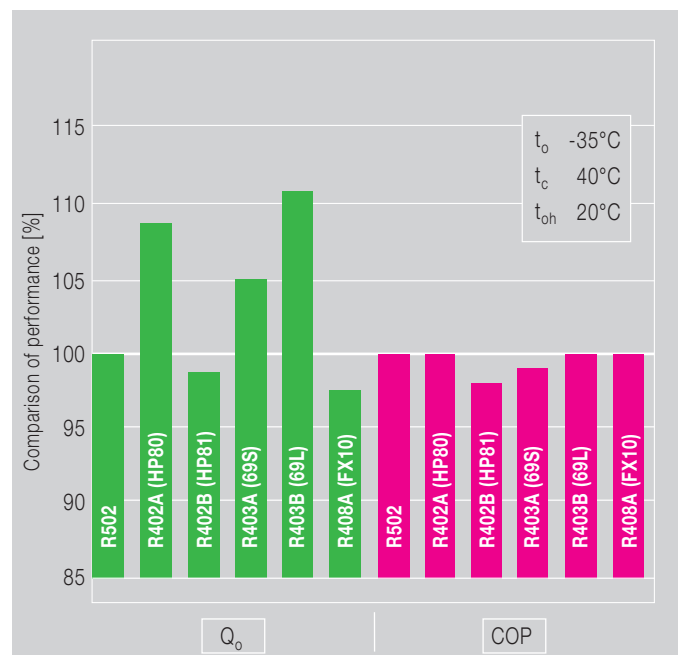

Fig. 16 Comparison of the performance data of a semi-hermetic compressor

Before conversion generously dimensioned suction gas filters and liquid line driers should therefore be fitted for cleaning and after approximately 100 hours operation an oil change should be made; further checks are recommended.

The operating conditions with R502 (including discharge gas temperature and suction gas superheat) should be noted so that a comparison can be made with the values after conversion. Depending upon the results regulating devices should possibly be reset and other additional measures should be taken as required.

**Supplementary BITZER information concerning the use of retrofit blends (see also <http://www.bitzer.de>)**

**□ Technical Information KT-650  
“Retrofitting of R12 and R502 refrigerating systems to alternative refrigerants”**

**Service blends as substitutes for R12 (R500)**

Although as experience already shows, R134a is also well suited for the conversion of existing R12 plants, the general use for such a "retrofit" procedure is not always possible. Not all compressors which have previously been installed are designed for the application with R134a. In addition a conversion to R134a requires the possibility to make an oil change, which is for example not the case with most hermetic type compressors.

Economical considerations also arise, especially with older plants where the effort in converting to R134a is relatively high. The chemical stability of such plants is also often insufficient and thus the chance of success is very questionable.

Therefore "Service blends" are also available for such plants as an alternative to R134a and are offered under the designations R401A/R401B (MP39/MP66 – DuPont), R409A ("Forane" FX56 – Arkema, Solvay).

The main components are the HCFC refrigerants R22, R124 and/or R142b. Either HFC R152a or R600a (Isobutane) is used as the third component. Operation with traditional lubricants (preferably semi or full synthetic) is also possible due to the major proportion of HCFC.

A further service blend was offered under the designation R413A (ISCEON49 – DuPont), but replaced by R437A by the end of 2008. However, for development-historic reasons of service blends, R413A will continue to be covered in this Report. The constituents of R413A consist of the chlorine free substances R134a, R218, and R600a. In spite of the high R134a content the use of conventional lubricants is possible because of the relatively low polarity of R218 and the favourable solubility of R600a.

R437A is a blend of R125, R134a, R600 and R601 with similar performance and properties as R413A. This refrigerant also has zero ODP.

However, due to the limited miscibility of R413A and R437A with mineral and alkylbenzene oils, oil migration may result in systems with a high oil circulation rate and/or a large liquid volume in the receiver – for example if no oil separator is installed.

If insufficient oil return to the compressor is observed, the refrigerant manufacturer recommends replacing part of the original oil charge with ester oil. But from the compressor manufacturer's view, such a measure requires a very careful examination of the lubrication conditions. For example, if increased foam formation in the compressor crankcase is observed, a complete change to ester oil will be necessary. Moreover, under the influence of the highly polarized blend of ester oil and HFC, the admixture of or conversion to ester oil leads to increased dissolving of decomposition products and dirt in the pipework. Therefore, generously dimensioned suction clean-up filters must be provided.

For further details, see the refrigerant manufacturer's "Guidelines".

**Resulting design criteria/  
Converting existing R12 plants**

Compressors and components can mostly remain in the system. However, when using R413A and R437A the suitability must be checked against HFC refrigerants. The actual "retrofit" measures are mainly restricted to changing the refrigerant (possibly oil) and a careful check of the superheat setting of the expansion valve. A significant temperature glide is present due to the relatively large differences in the boiling points of the individual substances, which demands an exact knowledge of the saturation conditions (can be found from vapour tables of refrigerant manufacturer) in order to assess the effective suction gas superheat.

In addition the application range must also be observed.

Different refrigerant types are required for high and low evaporating temperatures or distinct capacity differences must be considered (application ranges see page 40). This is due to the steeper capacity characteristic, compared to R12.

Due to the partially high proportion of R22 especially with the low temperature blends, the discharge gas temperature with some refrigerants is significantly higher than with R12. The application limits of the compressor should therefore be checked before converting.

The remaining application criteria are similar to those for the substitute substances for R502 which have already been mentioned.

\* By using R22 containing blends the legal requirements are to be followed, see also page 8.

**Supplementary BITZER information concerning the use of retrofit blends (see also <http://www.bitzer.de>)**

**□ Technical Information KT-650  
“Retrofitting of R12 and R502 refrigerating systems to alternative refrigerants”**

### R404A and R507A as substitutes for R502 and R22

These blends are chlorine free substitutes (ODP = 0) for R502 as well as for R22 in medium and low temperature ranges.

A composition which was already launched at the beginning of 1992 is known under the trade name "Suva" HP62 (DuPont). Long term use has shown good results. Further blends were traded as "Forane" FX70 (Arkema) and "Genetron" AZ50 (Allied Signal/Honeywell) or "Solkane" 507 (Solvay). In the mean time HP62 and FX70 have been listed in the ASHRAE nomenclature as R404A and AZ50 as R507A.

The basic components belong to the HFC group, where R143a belongs to the flammable category. Due to the combination with a relatively high proportion of R125 the flammability is effectively counteracted and also in the case of leakage.

A feature of all three ingredients is the very low isentropic compression exponent which results in a similar, with even a tendency to be lower, discharge gas temperature to R502 (Fig. 17). The efficient application of single stage compressors with low evaporating temperatures is therefore guaranteed.

Due to the similar boiling points for R143a and R125, with a relatively low proportion of R134a, the temperature glide with the ternary blend R404A within the relevant application range is less than one Kelvin. The characteristics within the heat exchangers are not therefore very different as with azeotropes. The results obtained so far from heat transfer measurements show favourable conditions.

R507A is a binary substance combination which even gives an azeotropic characteristic over a relatively wide range. The conditions therefore tend to be even better.

The performance found in laboratory tests (Fig. 18) gives hardly any difference between the various substances and show a large amount of agreement with R502. This also explains the high market penetration of these substitutes – they are essentially "standard" in commercial refrigeration systems in Europe and North America.

Questions concerning material compatibility are manageable; experience with other HFCs justifies a positive assessment. POE oils can be used as lubricants; the suitability of various alternatives is being investigated as well (see pages 9/10).

The relatively high global warming potential ( $GWP_{100} = 3922...3985$ ) which is mainly determined by the R143a and R125 is

something of a hitch. It is however improved compared to R502 and with regard to the favourable energy demand also leads to a reduction of the TEWI value. Other improvements are possible in this respect due to further developed system control.

Nevertheless, due to their high global warming potential (GWP), the use of R404A and R507A will no longer be allowed in the EU in new installations from 2020. This has already been settled in the F-Gas Regulation No. 517/2014 to be applied from 2015. However, the concurrent requirement on the phase-down in connection with a strict quota system will lead to an earlier phase-out in many applications. For more detailed information, please refer to BITZER brochure A-510.

In the US there are also initiatives (EPA recommendation) to phase out R404A and R507A from 2016. Other regions will probably follow.

Alternatives with lower GWP are the HFC blends dealt with in the following (from page 18) as well as HFO/HFC blends being developed and evaluated (from page 24).

Halogen free refrigerants or cascade systems using different refrigerants are also an option for specific applications (from page 27).

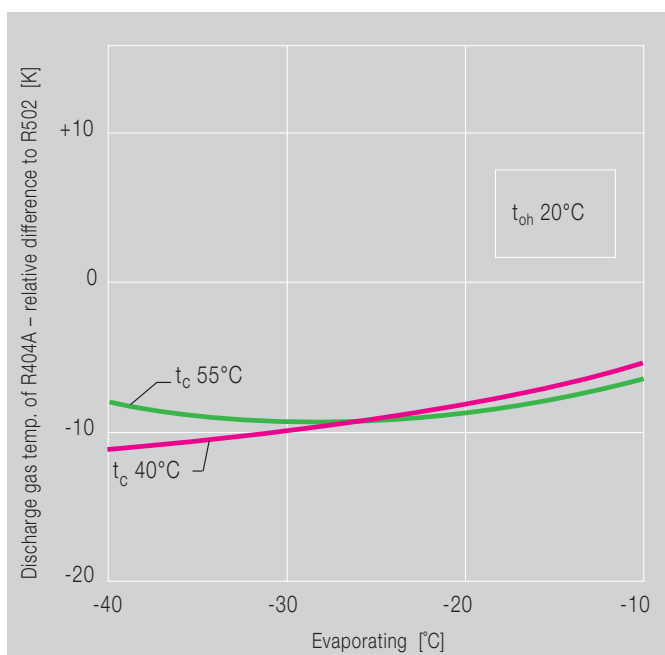

Fig. 17 R404A/R502 – comparison of discharge gas temperatures of a semi-hermetic compressor

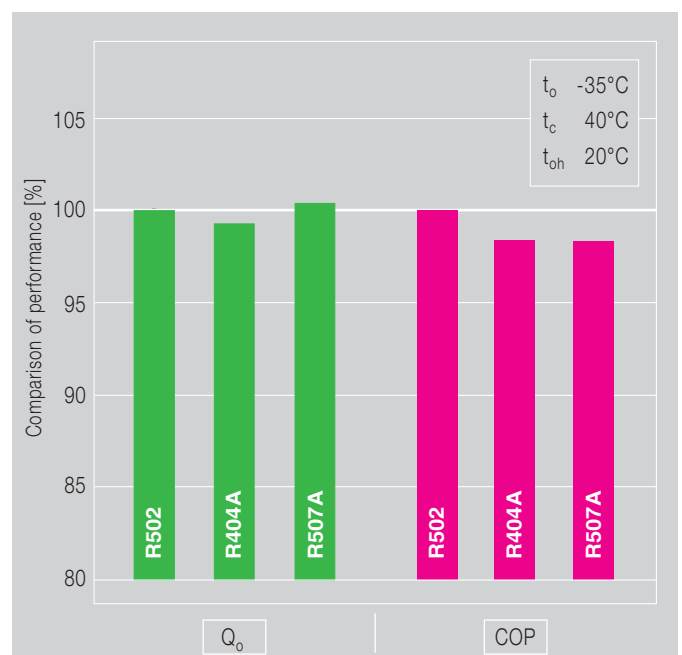

Fig. 18 Comparison of performance data of a semi-hermetic compressor

## Resulting design criteria

The system technology can be based on the experience with R502 over a wide area. On the thermodynamic side, a heat exchanger between the suction and liquid line is recommended as this will improve the refrigerating capacity and COP.

**BITZER offers the whole program of reciprocating, scroll and screw compressors for these blends.**

## Converting existing (H)CFC plants

Experience gained in investigative programs shows that qualified conversions are possible. However, major expenditure may be necessary depending on the system design.

## Supplementary BITZER information concerning the use of HFC blends (see also <http://www.bitzer.de>)

- Technical Information KT-651 "Retrofitting of R22 systems to alternative refrigerants"
- Technical Information KT-510 "Polyolester oils for reciprocating compressors"

## R407A/R407B/R407F as substitutes for R502 and R22

Alternatively to the earlier described substitutes additional mixture versions have been developed based on R32 which is chlorine free (ODP = 0) and flammable like R143a. The refrigerant R32 is also of the HFC type and initially seen as a candidate for R22 alternatives (page 20). However, due to extent of blend variations comparable thermodynamic characteristics to R404A/R507A can also be obtained.

Such kind of refrigerants were at first in the market under the trade name KLEA 60/61 (IC) and are listed as R407A/R407B\* in the ASHRAE nomenclature.

Honeywell has developed another blend with the trade name Performax LT (R407F according to ASHRAE nomenclature) and introduced it into the market. The R32 share is ten percentage points higher than the one in R407A while the R125 proportion is lower accordingly.

The necessary conditions, however, for alternatives containing R32 are not quite as favourable compared to the R143a based substitutes as dealt with earlier. The boiling point of R32 is very low at -52°C, in addi-

tion the isentropic compression exponent is even higher than with R22. To match the characteristics at the level of R404A and R507A therefore requires relatively high proportions of R125 and R134a. The flammability of the R32 is thus effectively suppressed, at the same time the large differences in the boiling points with a high proportion of R134a leads to a larger temperature glide.

The main advantage of R32 is the extraordinarily low global warming potential ( $GWP_{100} = 675$ ) so that even in combination with R125 and R134a it is significantly lower than with the R143a based alternatives mentioned above (R407A:  $GWP_{100} = 2107$ , R407F:  $GWP_{100} = 1825$ ).

With that they also comply with the requirement of the new EU F-Gas Regulation which from 2020 will only allow refrigerants of  $GWP < 2500$ .

Measurements made with R32 containing blends do show certain capacity reductions compared to R404A and R507A, with low evaporating temperatures, the COP however shows less deviation and is even higher in medium temperature applications (Fig. 20).

\* Meanwhile, R407B is no longer available in the market. Due to the historical development of HFC blends this refrigerant will, however, still be considered in this Report.

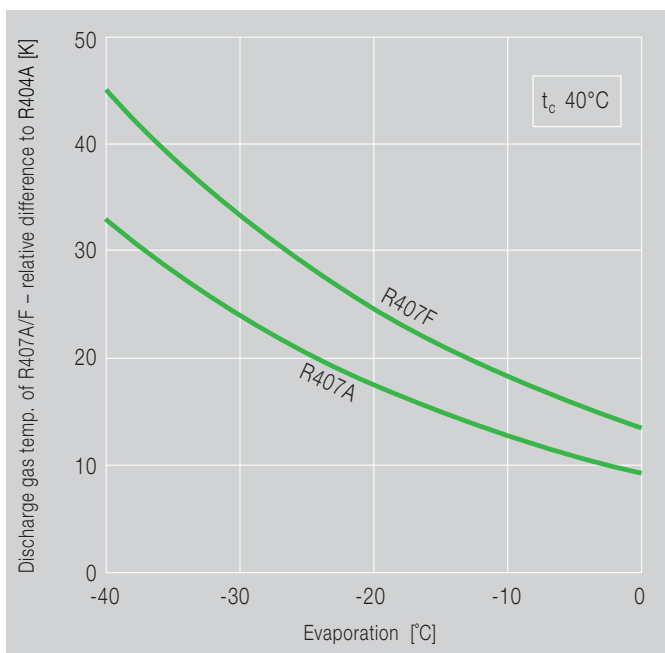

Fig. 19 R407A, R407F/R404A – comparison of discharge gas temperature of a semi-hermetic compressor

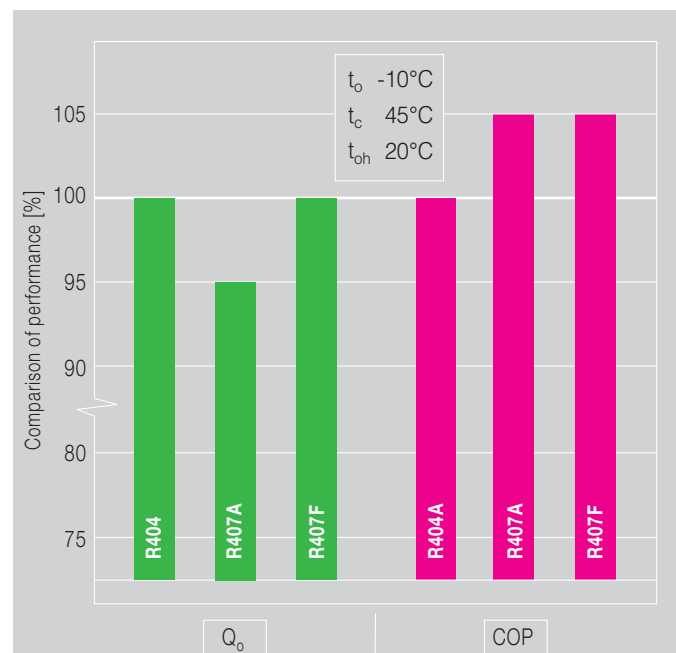

Fig. 20 Comparison of performance data of a semi-hermetic compressor



Whether these favourable conditions are confirmed in real applications is subject to the system design.

An important factor is the significant temperature glide which can have a negative influence upon the capacity/temperature difference of the evaporator and condenser. With regard to the material compatibility, R32 blends can be assessed similarly to R404A and R507A; the same applies to the lubricants.

Despite the relatively high proportion of R125 and R134a in the R32 blends the discharge gas temperature is higher than with the R143a based alternatives. This is in particular valid for R407F. As a result certain limitations occur in the application range as well as the requirement for additional cooling of compressors when operating at high pressure ratios.

2-stage compressors can be applied very efficiently where especially large lift conditions are found. An important advantage thereby is the use of a liquid subcooler.

### Resulting design criteria

The experience with R404A/R507A and R22 can be used for the plant technology in many respects, considering the temperature glide as well as the difference in the thermodynamic properties.

### Converting existing R22 plants

Practical experiences show that qualified conversions are possible. Compared to R22 the volumetric refrigeration capacity is nearly similar while the refrigerant mass flow is only slightly higher. These are relatively favourable conditions for the conversion of medium and low temperature R22 systems.

The main components can remain in the system provided that they are compatible with HFC refrigerants and ester oils. However, special requirements placed on the heat exchanger with regard to the significant temperature glide must be considered. A conversion to ester oil is also necessary, which leads to increased dissolving of decomposition products and dirt in the pipework. Therefore, generously dimensioned suction clean-up filters must be provided.

### Conversion of R404A/R507A systems

Larger differences in thermodynamic properties (e.g. mass flow, discharge gas temperature) and the temperature glide of R407A/F may require the replacement of control components and if necessary retrofitting of additional compressor cooling when existing systems are converted. In newly built systems a specific design of components and system must be made.

**BITZER offers a comprehensive program of semi-hermetic reciprocating compressors for R407A und R407F.**

**Supplementary BITZER information concerning the use of HFC blends (see also <http://www.bitzer.de>)**

❑ **Technical Information KT-651  
"Retrofitting of R22 systems to alternative refrigerants"**

### R422A as substitute for R502 and R22

Amongst other aims, R422A (ISCEON MO79 – DuPont) was developed in order to obtain a chlorine-free refrigerant (ODP = 0) for the simple conversion of existing medium and low temperature refrigeration systems using R502 and R22.

For this, it was necessary to formulate a refrigerant with comparable performance and energy efficiency to that of R404A, R507A, and R22, which also permits the use of conventional lubricants.

This pertains to a zeotropic blend of the basic components R125 and R134a with a small addition of R600a. Due to its relatively high R134a percentage, the temperature glide (Fig. 34) lies higher than for R404A, but lower than other refrigerants with the same component blends – such as R417A and R422D (see page 22).

The adiabatic exponent, compared to R404A and R507A, is smaller and therefore the discharge gas and oil temperatures of the compressor, too. Under extreme low temperature conditions this can be advantageous. In cases of low pressure ratio and

suction gas superheat this can be negative due to increased refrigerant solution if ester oil is used.

The material compatibility is comparable to the blends mentioned previously, the same applies to the lubricants, as well. On account of the good solubility of R600a, conventional lubricants can also be used under favourable circumstances.

In particular, advantages result during the conversion of existing R502 and R22 systems as mentioned above. However, for plants with high oil circulation rates and/or large liquid charge in the receiver, it is possible for oil migration to occur – for example if no oil separator is installed.

If insufficient oil return to the compressor is observed, the refrigerant manufacturer recommends replacing part of the original oil charge with ester oil. But from the compressor manufacturer's view, such a measure requires a very careful examination of the lubrication conditions. For example, if increased foam formation in the compressor crankcase is observed, a complete change to ester oil\* will be necessary. Under the influence of the highly polarized blend of ester oil and HFC, the admixture of or conversion to ester oil leads to increased dissolving of decomposition products and dirt in the pipework. Therefore, generously dimensioned suction clean-up filters must be provided.

For further details, see the refrigerant manufacturer's "Guidelines".

From a thermodynamic point of view a heat exchanger between suction and liquid line is recommended, thereby improving the cooling capacity and coefficient of performance. Besides this the resulting increase in operating temperatures leads to more favourable lubricating conditions (lower solubility).

\* General proposal for screw compressors and liquid chillers when used with DX evaporators with internally structured heat exchanger pipes. Furthermore, an individual check regarding possible additional measures will be necessary.

**BITZER compressors are suitable for R422A. An individual selection is possible upon demand.**

### HFC alternatives for R22

As the HCFC refrigerant R22 (ODP = 0.05) is accepted only as a transitional solution, a number of chlorine-free (ODP = 0) alternatives have been developed and tested extensively. They are already being used on a large range of applications.

Experience shows, however, that none of these substitutes can replace the refrigerant R22 in all respects. Amongst others there are differences in the volumetric refrigerating capacity, restrictions in possible applications, special requirements in system design or also considerably differing pressure levels. So various alternatives come under consideration according to the particular operating conditions.

Apart from the single-component HFC refrigerant R134a, these are mainly blends (different compositions) of the components R32, R125, R134a, R143a, and R600(a). The following description mainly concerns the development and potential applications of these. The halogen-free substitutes NH<sub>3</sub>, propane and propylene as well as CO<sub>2</sub> should also be considered, however, specific criteria must be applied for their use (described from page 27).

### R407C as substitute for R22

Blends of the HFC refrigerants R32, R125 and R134a are seen as the favourite candidates for shortterm substitution for R22 – their performance and efficiency are very similar (Fig. 21). At first two blends of the same composition have been introduced under the trade names AC9000\* (DuPont) and KLEA66\* (ICI). They are listed in the ASHRAE nomenclature as R407C. In the meantime there are also further blend varieties (e.g. R407A/R407F) with somewhat differing compositions, whose properties have been optimized for particular applications (see page 18).

Unlike the R502 substitutes with identical blend components (see pages 18/19), the R22 substitutes under consideration contain higher proportions of R32 and R134a. A good correspondence with the properties of R22 in terms of pressure levels, mass flow, vapour density and volumetric refrigerating capacity is thus achieved. In addition, the global warming potential is relatively low (GWP<sub>100</sub> = 1774), which is a good presupposition for favourable TEWI values.

With that R407C also complies with the requirement of the new EU F-Gas Regulation which from 2020 will only allow refrigerants with GWP < 2500.

The high temperature glide is a disadvantage for usual applications which requires appropriate system design and can have a negative influence on the efficiency of the heat exchangers (see explanations on pages 13/14).

Due to the properties mentioned, R407C is preferably an R22 substitute for air-conditioning systems and (within certain limitations) also for medium temperature refrigeration. In low temperature refrigeration, because of the high proportion of R134a, a significant drop in refrigerating capacity and COP is to be expected. There is also the danger of an increased R134a concentration in the blend in evaporators, with consequential reduction in performance and malfunctioning of the expansion valve (e.g. insufficient suction gas superheat).

Material compatibility can be assessed as similar to that of the blends discussed previously; the same applies to the lubricants.

\* Previous trade names are not used any more.

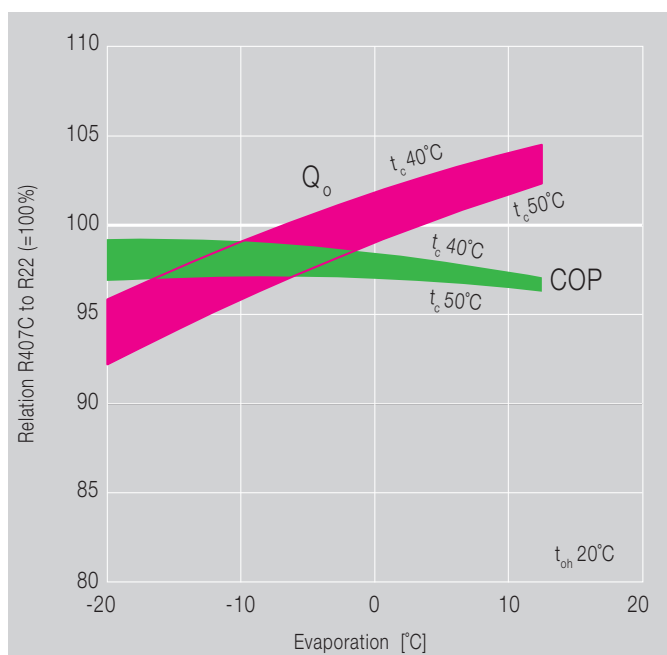

Fig. 21 R407C/R22 – comparison of performance data of a semi-hermetic compressor

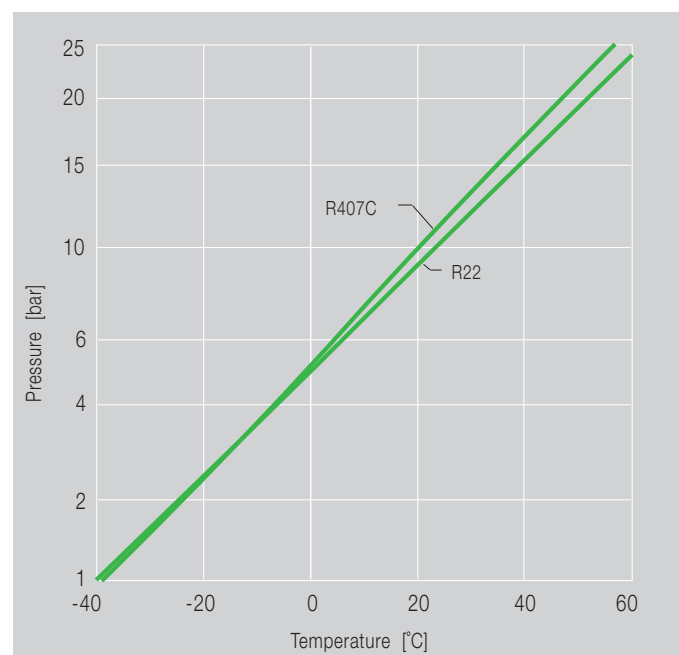

Fig. 22 R407C/R22 – comparison of pressure levels





**Resulting design criteria**

With regard to system technology, previous experience with R22 can only be utilized to a limited extent. The distinctive temperature glide requires a particular design of the main system components, e.g. evaporator, condenser, expansion valve. In this context it must be considered that heat exchangers should preferably be laid out for counter-flow operation and with optimized refrigerant distribution. There are also special requirements with regard to the adjustment of regulating devices and service handling.

Furthermore, the use in systems with flooded evaporators is not recommended as this would result in a severe concentration shift and layer formation in the evaporator.

**BITZER can supply a widespread range of semi-hermetic reciprocating, screw and scroll compressors for R407C.**

**Converting existing R22 plants**

Because of the above mentioned criteria, no general guidelines can be defined. Each case must therefore be examined individually.

**R410A as substitute for R22**

In addition to R407C, there is a near azeotropic blend being offered with the ASHRAE designation R410A. It is widely used already, mainly in air conditioning applications.

An essential feature indicates nearly 50% higher volumetric cooling capacity (Fig. 23/1) in comparison to R22, but with the consequence of a proportional rise in system pressures (Fig. 23/2).

At high condensing temperatures, energy consumption/COP initially seems to be less favourable than with R22. This is mainly due to the thermodynamic properties. On the other hand, very high isentropic efficiencies are achievable (with reciprocating and scroll compressors), whereby the differences are lower in reality.

Added to this are the high heat transfer coefficients in evaporators and condensers determined in numerous test series, with resulting especially favourable operating conditions. With an optimized design, it is quite possible for the system to achieve a better overall efficiency than with other refrigerants.

Because of the negligible temperature glide (< 0.2 K), the general usability can be seen similar to a pure refrigerant.

The material compatibility is comparable to the previously discussed blends and the same applies for the lubricants. However, the pressure levels and the higher specific loads on the system components need to be taken into account.

**Resulting design criteria**

The fundamental criteria for HFC blends also apply to the system technology with R410A, however the extreme high pressure levels have to be considered (43°C condensing temperature already corresponds to 26 bar abs.).

Compressors and other system components designed for R22 are not suitable for this refrigerant or only to a limited extent.

The availability of suitable compressors and system components has been secured in the meantime.

When considering to cover usual R22 application ranges, the significant differences in the thermodynamic properties (e.g. pressure levels mass and volume flow, vapour density) must be evaluated.

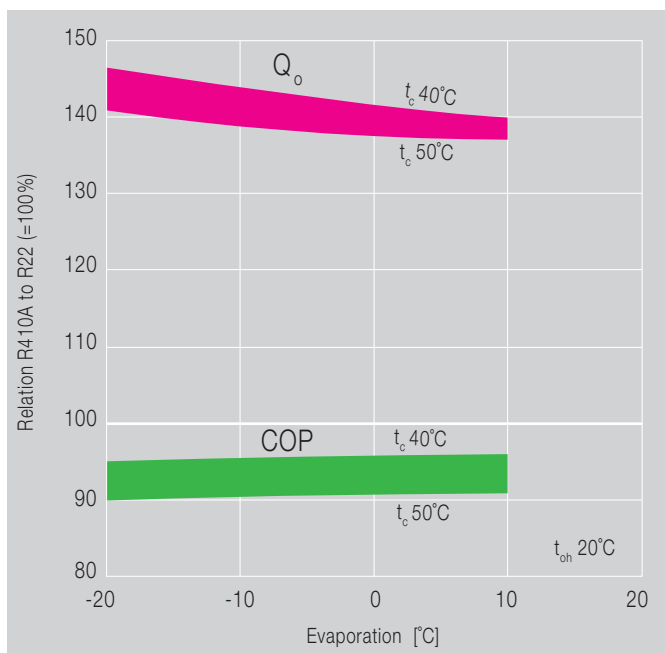

Fig. 23/1 R410A/R22 – comparison of performance data of a semi-hermetic compressor

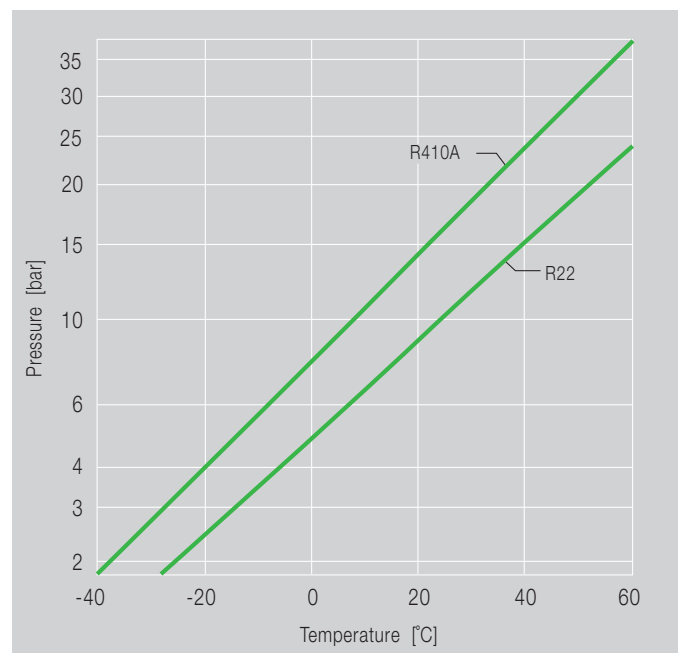

Fig. 23/2 R410A/R22 – comparison of pressure levels

This also requires considerable constructional changes to compressors, heat exchangers, and controls, as well as measures of tuning vibrations.

In addition, safety requirements are concerned also affecting the quality and dimensions of piping and flexible tube elements (for condensing temperatures of approx. 60°C/40 bar).

Another criterion is the relatively low critical temperature of 73°C. Irrespective of the design of components on the high pressure side, the condensing temperature is thus limited.

**For R410A, BITZER offers a series of semi-hermetic reciprocating compressors and scroll compressors.**

### **R417A/417B/422D/438A as substitutes for R22**

The same as for R422A (page 19), one of the aims for these developments was to provide chlorine-free refrigerants (ODP = 0) for the simple conversion of existing R22 plants.

R417A was introduced to the market several years ago, and is also offered under the trade name ISCEON MO59 (DuPont). This substitute for R22 contains the blend components R125/R134a/R600, and therefore differs considerably from e.g. R407C with a correspondingly high proportion of R32.

Meanwhile, a further refrigerant based on identical components, but with a higher R125 content, has been offered under the trade name Solkane 22L (Solvay) – ASHRAE classification R417B. Due to its lower R134a content, the volumetric refrigerating capacity as well as the pressure levels are higher than with R417A. This results in different performance parameters and emphasis in the application range.

The same applies to a further blend with the same main components, but R600a as hydrocarbon additive. It is offered under trade name ISCEON MO29 (DuPont) and listed as R422D in the ASHRAE nomenclature.

A refrigerant also belonging to the category of HFC/HC blends was introduced in 2009 under the trade name ISCEON MO99 (DuPont) – ASHRAE classification R438A. This formulation was selectively designed for a higher critical temperature for applications in hot climate areas. The base components are R32, R125, R134a, R600 and R601a.

Like R407C, all four substitute refrigerants are zeotropic blends with a more or less significant temperature glide. In this respect the criteria described in connection with R407C are also valid.

Apart from similar refrigeration capacity there are fundamental differences in thermodynamic properties and in oil transport behaviour. The high proportion of R125 causes with R417A/B and R422D a higher mass flow than with R407C, a lower discharge gas temperature and a relatively high superheating enthalpy. These properties indicate that there are differences in the optimization of system components and a heat exchanger between liquid and suction lines is of advantage.

Despite the predominant proportion of HFC refrigerants the use of conventional lubricants is possible to some extent because of the good solubility properties of the hydrocarbon constituent. However, in systems with a high oil circulation rate and/or a large volume of liquid in the receiver oil migration may result.

In such cases, additional measures are necessary. For further information on oil return and lubricants, see the previous section on "R422A as substitute for R502 and R22" (page 19).

**BITZER compressors are suitable for the described refrigerants.**

**An individual selection is possible upon demand.**

### **R427A as a substitute for R22**

This refrigerant blend was introduced some years ago under the trade name Forane FX100 (Arkema). In the meantime it is listed in the ASHRAE nomenclature as R427A.

The R22 substitute is offered for the conversion of existing R22 systems for which a "Zero ODP" solution is requested. This refrigerant is an HFC mixture with base components R32/R125/R143a/R134a.

In spite of the blend composition based on pure HFC refrigerants, the manufacturer states that a simplified conversion procedure is possible.

This is positively influenced by the R143a proportion. Accordingly, when converting from R22 to R427A, all it takes is a replacement of the original oil charge with ester oil. Additional flushing sequences are not required, as proportions of up to 15% of mineral oil and/or alkyl benzene have no significant effect on oil circulation in the system.

However, it must be taken into account that under the influence of the highly polarized mixture of ester oil and HFC increased dissolving of decomposition products and dirt in the pipework is caused. Therefore, generously dimensioned suction clean-up filters must be provided.

Regarding refrigerating capacity, pressure levels, mass flow and vapor density R427A is relatively close to R22. During retrofit essential components such as expansion valves can remain in the system. Due to the high proportion of blend components with low adiabatic exponent the discharge gas temperature is considerably lower than with R22 which has a positive effect at high compression ratios.

It must be taken into account that this is also a zeotropic blend with a distinct temperature glide. Therefore the criteria as described in context with R407C are valid here as well.

**BITZER compressors are suitable for R427A. An individual selection is possible upon demand.**

**Supplementary information concerning the use of HFC blends**  
(see also <http://www.bitzer.de>)

- **Technical information KT-651**  
“Retrofitting R22 systems to alternative refrigerants”

### R32 as substitute for R22

As described earlier R32 belongs to the HFC refrigerants group but initially was mainly used as a component of refrigerant blends only. An essential barrier for the application as a pure substance so far is the flammability classification in safety group A2L. This requires adequate charge limitations and/or additional safety measures, especially with installations inside buildings. In addition there are very high pressure levels and discharge gas temperatures (compression index higher than with R22 and R410A).

On the other hand R32 has favorable thermodynamic properties, e.g. very high evaporating enthalpy and volumetric refrigerating capacity, low vapor density (low pressure drop in pipelines), low mass flow and favorable power input for compression. Besides that the global warming potential is low ( $GWP_{100} = 675$ ).

Looking at these favorable properties and taking into account the additional and strived for emission reductions, R32 will increasingly

also be used as a refrigerant in factory produced systems (A/C units and heat pumps) with low refrigerant charges. Concerning safety requirements the regulations (e.g. according to EN 378) for A2 refrigerants are still valid although it was proven in flammability tests that the necessary ignition energy is very high and the flame speed is low. Based on these properties R32 (like R1234yf and R1234ze) has been put into the new safety group A2L according to ISO 817.

To what extent the safety demands for A2L refrigerants (as opposed to A2) can be relieved in future can not finally be judged today. Therefore, individual risk analyses are required.

**BITZER scroll compressors of series GSD6/GSD8 can be delivered for laboratory tests with R32. A customized design is available upon request.**

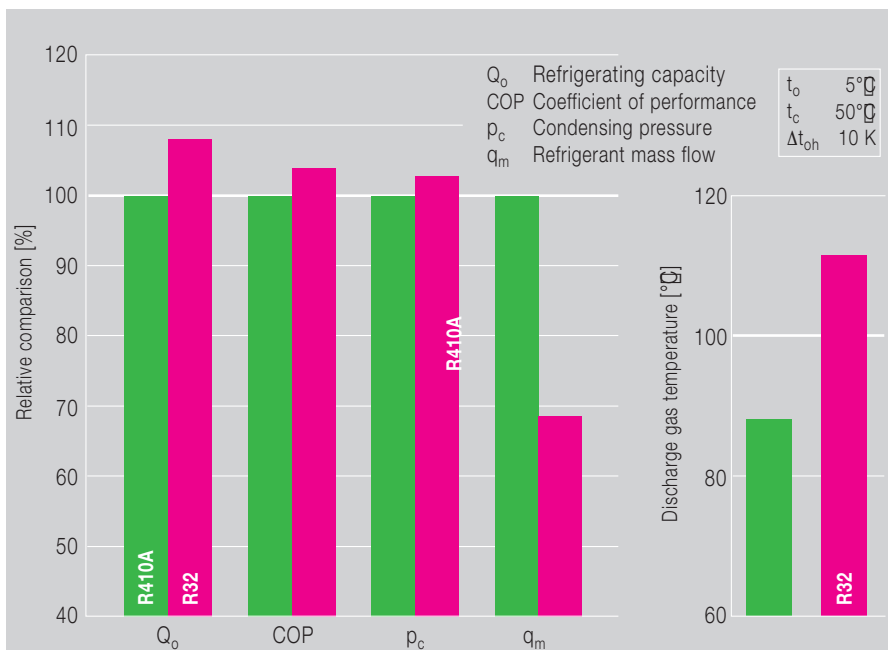

**Abb. 24** R32/R410A – comparison of performance and operating data of a scroll compressor

## HFO/HFC blends as alternatives to HFCs

Due to the decision with the use of the "Low GWP" refrigerant HFO-1234yf (see pages 11/12) in automotive air-conditioning systems, the development of alternatives for other mobile applications and stationary systems has meanwhile also been initiated.

The primary goals are the formulation of blends with significantly reduced GWP while maintaining similar thermodynamic properties to those of the HFCs used predominantly today.

The base components are the refrigerants R1234yf and R1234ze(E), which belong to the group of hydro fluoro olefins (HFO) with a chemical double bond. Due to their combination of properties, they are characterized as preferred candidates. However, both refrigerants are flammable (safety group A2L). Moreover, their volumetric refrigerating capacity is low. That of R1234yf is approximately at the level of R134a and that of R1234ze(E) is even more than 20% lower.

The list of additional potential refrigerants from the HFO group is relatively long. However, there are only few substances that meet the requirements in terms of thermodynamic properties, flammability, toxicity, chemical stability, compatibility with materials and lubricants. They include, for example, low-pressure refrigerants such as R1336mzzZ (DuPont DR-2) and R1233zd(E) which, however, are primarily an option for chillers with large centrifugal compressors or can be used with positive displacement compressors in high temperature applications. Furthermore, R1233zd(E) has a (very) low ozone depleting potential (ODP), which may lead to restrictions in its use.

On the other hand, currently there are no suitable candidates of similar volumetric refrigerating capacity as R22/R407C, R404A/R507A and R410A with prospects for commercial application. Direct alternatives for these refrigerants of significantly lower GWP must therefore be "formulated" as a blend of R1234yf and/or R1234ze(E) with HFC refrigerants, and possible small proportions of hydrocarbons.

However, due to the properties of the HFC refrigerants suitable as blend components, flammability and GWP are related diametrically to one another. In other words:

Blends as alternatives to R22/R407C of GWP < approx. 900 to 1000 are flammable. This is also true with alternatives for R404A/R507A and R410A in blends of GWP < approx. 1300 to 1400. The reason for this is the high GWP of each of the required non-flammable components. For R134a alternatives, the situation is more favorable. Due to the already relatively low GWP of R134a, a blend with R1234yf and/or R1234ze(E) enables a formulation of non-flammable refrigerants with a GWP of approx. 600.

Currently there are two directions of development:

- ❑ Non-flammable HFC alternatives (blends) with GWP values according to the above mentioned limits – safety group A1. Regarding safety requirements these refrigerants can then be utilized the same way as currently used HFCs
- ❑ Flammable HFC alternatives (blends) with GWP values below the above mentioned possible limits – according to safety group A2L (for refrigerants of low flammability). See also explanations on page 11.

Among others this group of refrigerants is then subject to charge limitations according to today's requirements for A2 refrigerants.

To what extent the safety requirements for A2L refrigerants (compared to A2) can be relieved, can only be assessed by individual risk analyses.

### Non-flammable R134a alternatives

As mentioned before, the most favorable starting situation for developing non-flammable blends exists for R134a alternatives.

For them, GWP values of approx. 600 can be achieved. This is less than half compared with R134a (GWP<sub>100</sub> = 1430). In addition to that, this type of blend versions can have azeotropic properties, which is why they can be used like pure refrigerants.

For quite some time a blend has been tested on a large scale in real systems – this was developed by DuPont, and is called Opteon® XP-10. Results available today are promising.

This is also true for an R134a alternative designated Solstice N-13 and offered by Honeywell which, however, differs regarding the blend composition.

Meanwhile the refrigerants are listed in the ASHRAE nomenclature under R513A (DuPont) and R450A (Honeywell).

The same category also includes the refrigerant blends ARM-42 (ARKEMA) as well as AC5X (Mexichem).

All options have refrigerating capacity, power input, and pressure levels similar to R134a. As a result components and system technology can be taken over. Just minor changes like e.g. superheat adjustment of the expansion valves is necessary.

Polyolester oils are suitable lubricants which must meet special requirements, e.g. for the utilization of additives.

Very favorable perspectives arise in super-market applications in the medium temperature range in a cascade with CO<sub>2</sub> for low temperature, just as in liquid chillers with higher refrigerant charges where the use of flammable or toxic refrigerants would require comprehensive safety measures.

### Alternatives for R22/R407C, R404A/R507A and R410A

Since the available HFO molecules (R1234yf und R1234ze) show a considerably smaller volumetric refrigerating capacity compared to the above mentioned HFC refrigerants, for the particular alternatives relatively large HFC proportions with high volumetric refrigerating capacity must be added. The potential list of candidates is rather limited. R32 with relatively low GWP is one option. However, a negative aspect is its flammability (A2L), resulting also in a flammable blend upon adding fairly large proportions in order to increase the volumetric refrigerating capacity while maintaining a favorable GWP.

Actual HFC Refrigerants	Alternatives		Components / Mixture components "Low GWP" alternatives							
	Safety Group ↓	GWP ↓	R1234yf A2L GWP 4	R1234ze(E) A2L 7	R32 A2L 675	R152a A2 124	R134a A1 1430	R125 A1 3500	CO <sub>2</sub> <sup>②</sup> A1 1	R290 <sup>②</sup> A3 3
R134a (GWP 1430)	A1 A2L A2L	~ 600 < 150 < 10	✓ ✓ ✓	✓ ✓ ✓	✓	✓	✓			
R404A/R507A (GWP 3922/3985)	A1 A1 A2L A2L <sup>③</sup> A2	< 2500 <sup>①</sup> < 1400 < 250 < 150 < 150	✓ ✓ ✓ ✓ ✓	✓	✓ ✓ ✓ ✓ ✓	✓	✓	✓ ✓		✓ ✓ ✓
R22/R407C (GWP 1810/1774)	A1 A2L A2L <sup>③</sup> A2	900..1400 < 250 < 150 < 150	✓ ✓ ✓ ✓	✓	✓ ✓ ✓ ✓	✓	✓	✓		✓
R410A (GWP 2088)	A2L A2L	< 750 < 500	✓	✓	✓ ✓				✓	

- ① Refrigerating capacity, mass flow, discharge gas temperature similar to R404A
- ② Only low percentage – due to temperature glide (CO<sub>2</sub>) and flammability (R290)
- ③ Significantly lower refrigerating capacity than reference refrigerant

Abb. 25/1 Potential mixture components for "Low GWP" alternatives (Examples)

Current HFC refrigerant	"Low GWP" Alternatives for HFC refrigerants <sup>③</sup>					
	ASHRAE Number	Trade Name		Composition (with blends)	GWP <sup>④</sup> (AR4)	Safety Group
R134a (GWP 1430) <sup>①</sup>	R513A	Opteon® XP10	DuPont	R1234yf/134a	631	A1
	R450A	Solstice N-13	Honeywell	R1234ze(E)/134a	601	A1
	-	AC5X	Mexichem	R32/1234ze(E)/134a	620	A1
	R1234yf	various		-	4	A2L
	R1234ze(E) <sup>②</sup>	various		-	7	A2L
-	ARM-42	Arkema	R1234yf/152a/134a	< 150	A2L	
R404A/R507A (GWP 3922/3985)	R449A	Opteon® XP40	DuPont	R32/125/1234yf/134a	1397	A1
	R448A	Solstice N-40	Honeywell	R32/125/1234yf/1234ze(E)/134a	1386	A1
	-	ARM-32b	Arkema	not disclosed	~ 1400	A1
	-	LTR4X	Mexichem	R32/125/1234ze(E)/134a	1295	A1
	R452A	Opteon® XP44	DuPont	R32/125/1234yf	2140	A1
	-	ARM-35	Arkema	not disclosed	~ 2150	A1
	-	Opteon® XL40	DuPont	R32/1234yf	246	A2L
	-	Solstice L4F	Honeywell	not disclosed	145	A2L
-	ARM-20a/20b	Arkema	not disclosed	< 150 / ~ 250	A2L	
-	ARM-25	Arkema	not disclosed	< 150	A2	
R22/R407C (GWP 1810/1774)	-	DR-91	DuPont	not disclosed	949	A1
	-	Solstice N-20	Honeywell	R32/125/1234yf/1234ze(E)/134a	975	A1
	-	ARM-32c	Arkema	not disclosed	~ 1350	A1
	-	DR-3	DuPont	R32/1234yf	148	A2L
	R444B	Solstice L-20	Honeywell	R32/152a/1234ze(E)	294	A2L
R410A (GWP 2088)	R32	various		-	675	A2L
	-	Opteon® XL41	DuPont	R32/1234yf	466	A2L
	R447A	Solstice L-41	Honeywell	R32/125/1234ze(E)	582	A2L
	-	ARM-71a	Arkema	not disclosed	< 500	A2L
	-	HPR1D	Mexichem	R32/R1234ze(E)/CO <sub>2</sub>	407	A2L

- ① The relatively low GWP allows the use of R134a also longer term
- ② Significantly lower refrigerating capacity than reference refrigerant
- ③ A number of refrigerants listed above are declared by the manufacturer as development products. This is subject for possible changes in composition and product name
- ④ AR4: according to IPCC IV

Abb. 25/2 "Low GWP" Alternatives for HFC refrigerants



On the other hand, when formulating as a non-flammable blend a relatively large proportion of refrigerants with high fluorine content (e.g. R125) must be added which allows the flammability to be suppressed. A drawback here is the relatively high GWP of these chemicals. This results in GWP values of more than approx. 900 for non-flammable R22/R407C alternatives and more than approx. 1300 with options for R404A/R507A. Compared to R404A/R507A, however, this means a reduction down to a third.

The future drastic phase-down of F-Gases, e.g. as part of the EU F-Gas Regulation, leads already today to a demand for R404A/R507A substitutes with GWP values clearly below 500. Although this is possible with an adequate composition of the blend (high proportions of HFO, R152a, possibly also hydrocarbons), the disadvantage will be its flammability (safety groups A2L or A2). In this case, the application will have higher safety requirements and the need of an adequately adjusted system technology.

For R410A there is no non-flammable alternative on the horizon. Either R32 (see page 23) as pure substance or blends of R32 and HFO can be used for this. Due to its high volumetric refrigerating capacity this requires a very high proportion of R32, which is why only GWP values in the range from approx. 400 to 600 can be achieved. With a higher HFO proportion, the GWP can be reduced even further, but at the cost of a clearly reduced refrigerating capacity.

All blend options described above show a more or less distinct temperature glide due to significant boiling point differences. The same criteria apply as described in context with R407C.

Beyond that the discharge gas temperature of most R404A/R507A alternatives is considerably higher compared to the corresponding HFC blends.

In single stage low temperature systems this may lead to restrictions in the compressor application range or require special measures for additional cooling.

In transport applications or in low temperature systems with smaller condensing units, the compressors used can often not meet the required operating ranges, due to the high discharge gas temperatures. This is why refrigerant blends on basis of R32 and HFO with a relatively high proportion of R125 have also been developed. The GWP is slightly above 2000, but below the limit of 2500 set in the EU F-Gas Regulation from 2020. The main advantage of such blends is their moderate discharge gas temperature, which allows the operation within the typical application limits of R404A.

Fig. 25/1 shows an overview of the potential blend components for the alternatives described above. With some refrigerants the mixture components for R22/R407C and R404A/R507A substitutes are identical but their distribution in percent is different.

Meanwhile suitable blend versions for laboratory tests, some of them also for field tests or real applications are being offered primarily by DuPont, Honeywell, Arkema and Mexichem. A series of refrigerants are still to be considered development products, which for various reasons are not yet distributed commercially. Until now trade names are mainly used although some HFO/HFC blends are already listed in the ASHRAE nomenclature.

Fig. 25/2 lists a range of currently available refrigerants or refrigerants declared as development products. For some of them the blend components are also given. Due to the large number of different versions and the potential changes in development products, BITZER has so far tested only some of the new refrigerants. This is why in the tables on pages 38/39 (Fig. 33/34) for the time being only refrigerant properties of non-flammable alternatives for R134a and R404A/R507A (GWP < 1500) are listed which have already received an ASHRAE number.

For testing the "Low GWP" refrigerants AHRI (USA) has initiated a test program entitled "Alternative Refrigerants Evaluation Program (AREP)". It was established to

investigate and evaluate a series of the products including halogen-free refrigerants. A part of them is also listed in Fig. 25/2. The first phase of the project has been completed, and further investigations including those in special applications have already been initiated.

From a compressor manufacturer's point of view there should be an aim for limiting the product variety currently becoming apparent and to reduce the future offer to a few "standard refrigerants". It will not be possible for component and equipment manufacturers nor for installers and service companies to deal in practice with a larger range of alternatives.

**BITZER is strongly involved in various projects dealing with HFO/HFC blends and has already gained important knowledge in the use of these refrigerants. Semi-hermetic reciprocating compressors of the ECOLINE series and CS. and HS. Screw compressors can be used with the new refrigerant generation in laboratory and field tests. Scroll compressors of series GSD6/GSD8 have been released for laboratory tests with R32 or R32/HFO blends. An individual compressor selection is possible on demand. For further information see brochure A-510, section 6 and brochure No. 378 20 386.**



### NH<sub>3</sub> (Ammonia) as alternative refrigerant

The refrigerant NH<sub>3</sub> has been used for more than a century in industrial and larger refrigeration plants. It has no ozone depletion potential and no direct global warming potential. The efficiency is at least as good as with R22, in some areas even more favourable; the contribution to the indirect global warming effect is therefore small.

In addition it is incomparably low in price. Summarized, is this then an ideal refrigerant and an optimum substitute for R22 or an alternative for HFCs!? NH<sub>3</sub> has indeed very positive features, which can also be mainly exploited in large refrigeration plants.

Unfortunately there are also negative aspects, which restrict the wider use in the commercial area or require costly and sometimes new technical developments.

A disadvantage with NH<sub>3</sub> is the high isentropic exponent (NH<sub>3</sub> = 1.31 / R22 = 1.19 / R134a = 1.1), that results in a discharge temperature which is even significantly higher than that of R22. Single stage compression is therefore already subject to certain restrictions below an evaporating temperature of around -10°C.

The question of suitable lubricants is also not satisfactorily solved for smaller plants in some kinds of applications. The oils used previously were not soluble with the refrigerant. They must be separated with complex technology and seriously limit the use of "direct expansion evaporators" due to the deterioration in the heat transfer.

Special demands are made on the thermal stability of the lubricants due to the high discharge gas temperatures. This is especially valid when automatic operation is considered where the oil should remain for years in the circuit without losing any of its stability.

NH<sub>3</sub> has an extraordinarily high enthalpy difference and as a result a relatively small circulating mass flow (approximately 13 to 15% compared to R22). This feature which

is favourable for large plants makes the control of the refrigerant injection more difficult with small capacities.

A further criteria which must be considered is the corrosive action on copper containing materials; pipe lines must therefore be made in steel. Apart from this the development of motor windings resistant to NH<sub>3</sub> is also hindered. Another difficulty arises from the electrical conductivity of the refrigerant with higher moisture content.

Additional characteristics include toxicity and flammability, which require special safety measures for the construction and operation of such plants.

#### Resulting design and construction criteria

Based on the present "state of technology", industrial NH<sub>3</sub> systems demand totally different plant technology, compared to usual commercial systems.

Due to the insolubility with the lubricating oil and the specific characteristics of the refrigerant, high efficiency oil separators and also flooded evaporators with gravity or pump circulation are usually employed. Because of the danger to the public and to the product to be cooled, the evaporator often cannot be installed directly at the cold space. The heat transport must then take place with a secondary refrigerant circuit.

Two stage compressors or screw compressors with generously sized oil coolers, must already be used at medium pressure ratios, due to the unfavorable thermal behaviour.

Refrigerant lines, heat exchangers and fittings must be made of steel; larger size pipe lines are subject to examination by a certified inspector.

Corresponding safety measures and also special machine rooms are required depending upon the size of the plant and the refrigerant charge.

The refrigeration compressor is usually of "open" design, the drive motor is a separate component.

These measures significantly increase the expenditure involved for NH<sub>3</sub> plants, especially in the medium and smaller capacity area.

Efforts are therefore being made world-wide to develop simpler systems which can also be used in the commercial area.

A part of the research programs is dealing with part soluble lubricants, with the aim of improving oil circulation in the system. Simplified methods for automatic return of non-soluble oils are also being examined as an alternative.

**BITZER is strongly involved in these projects and has a large number of compressors operating. The experiences up to now have revealed that systems with part soluble oils are difficult to govern. The moisture content in the system has an important influence on the chemical stability of the circuit and the wear of the compressor. Besides, high refrigerant solution in the oil (wet operation, insufficient oil temperature) leads to strong wear on the bearings and other moving parts. This is due to the enormous volume change when NH<sub>3</sub> evaporates in the lubricated areas.**

**These developments are being continued. The emphasis is also on alternative solutions for non-soluble lubricants.**

Besides to this various equipment manufacturers have developed special evaporators, where the refrigerant charge can be significantly reduced.

In addition to this there are also developments for the "sealing" of NH<sub>3</sub> plants. This deals with compact liquid chillers (charge below 50 kg), installed in a closed container and partly with an integrated water reservoir to absorb NH<sub>3</sub> in case of a leak. This type of compact unit can be installed in areas which were previously reserved for plants with halogen refrigerants due to the safety requirements.

An assessment of the use of NH<sub>3</sub> compact systems – in place of systems using HFC refrigerants and conventional technology – is only possible on an individual basis, taking into account the particular application. From the purely technical view-point and presupposing an acceptable price level, it is anticipated that a wider range of products will become available.

The product range from BITZER today includes an extensive selection of optimized NH<sub>3</sub> compressors for various types of lubricants:

- Single stage open reciprocating compressors (displacement 19 to 152 m<sup>3</sup>/h with 1450 rpm) for air-conditioning, medium temperature and Booster applications
- Open screw compressors (displacement 84 to 1015 m<sup>3</sup>/h – with parallel operation to 4060 m<sup>3</sup>/h – with 2900 rpm) for air-conditioning, medium and low temperature cooling.  
Options for low temperature cooling:
  - Single stage operation
  - Economiser operation
  - Booster operation

### Conversion of existing plants

The refrigerant NH<sub>3</sub> is not suitable for the conversion of existing (H)CFC or HFC plants; they must be constructed completely new with all components.

### Supplementary BITZER information concerning the application of NH<sub>3</sub> (see also <http://www.bitzer.de>)

- Technical Information KT-640 “Application of Ammonia (NH<sub>3</sub>) as an alternative refrigerant”

### R723 (NH<sub>3</sub>/DME) as an alternative to NH<sub>3</sub>

The previously described experiences with the use of NH<sub>3</sub> in commercial refrigeration plants with direct evaporation caused further experiments on the basis of NH<sub>3</sub> under the addition of an oil soluble refrigerant component. The main goals were an improvement of the oil transport characteristics and the heat transmission with conventional lubricants along with a reduced discharge gas temperature for the extended application range with single stage compressors.

The result of this research project is a refrigerant blend of NH<sub>3</sub> (60%) and dimethyl ether "DME" (40%), developed by the "Institut fuer Luft- und Kaeltetechnik, Dresden", Germany (ILK), that has been applied in a series of real systems. As a largely inorganic refrigerant it received the designation R723 due to its average molecular weight of 23 kg/kmol in accordance to the standard refrigerant nomenclature.

DME was selected as an additional component for its properties of good solubility and high individual stability. It has a boiling point of -26°C, a relatively low adiabatic exponent, is non toxic and is available in a high technical standard of purity.

In the given concentration NH<sub>3</sub> and DME form an azeotropic blend characterised by a slightly rising pressure level in comparison to pure NH<sub>3</sub>. The boiling point lies at -36.5°C (NH<sub>3</sub> -33.4°C), 26 bar (abs.) of condensing pressure corresponds to 58.2°C (NH<sub>3</sub> 59.7°C).

The discharge gas temperature in air-conditioning and medium temperature ranges decrease by about 10 to 25 K (Fig. 26/1) and thereby allows for an extension of the application range to higher pressure ratios. On the basis of thermodynamic calculations

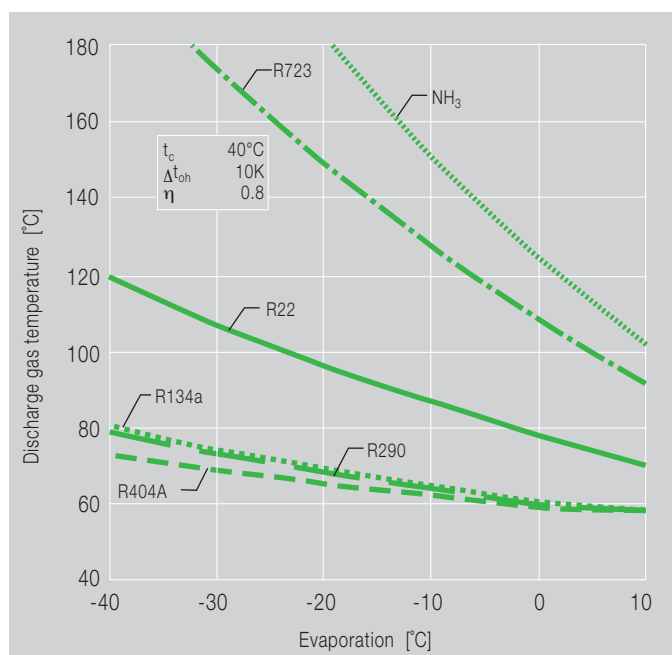

Fig. 26/1 Comparison of discharge gas temperatures

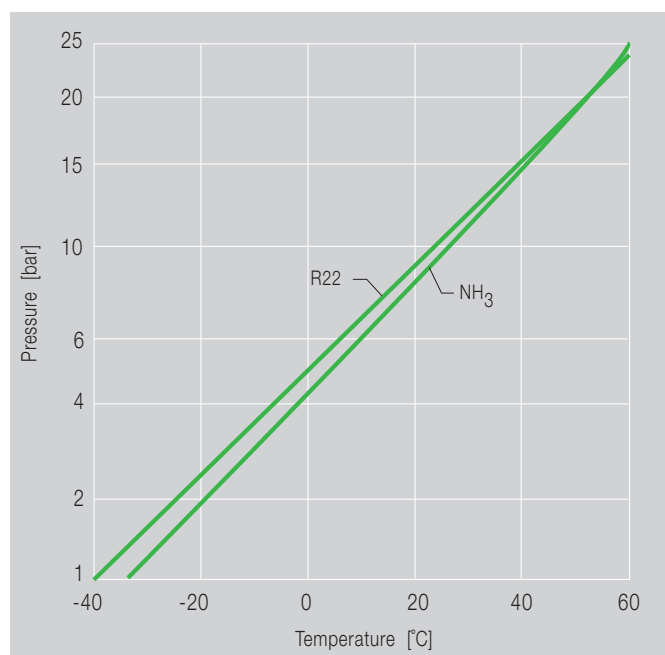

Fig. 26/2 NH<sub>3</sub>/R22 – comparison of pressure levels

a single-digit percent rise in cooling capacity results when compared to  $\text{NH}_3$ . The coefficient of performance is similar and is even more favourable at high pressure ratios, which experiments have confirmed. Due to the lower temperature level during compression an improved volumetric and isentropic efficiency is also to be expected, at least with reciprocating compressors in case of an increasing pressure ratio.

Due to the higher molecular weight of DME, mass flow and vapour density increase with respect to  $\text{NH}_3$  by nearly 50% which is of little importance to commercial plants, especially in short circuits. In classical industrial refrigeration plants, however, this is a substantial criterion with regard to pressure drops and refrigerant circulation. Also from these considerations it can be clearly seen that in commercial applications and especially in water chillers, R723 has its preferred utilisation.

The material compatibility is comparable to that of  $\text{NH}_3$ . Although non-ferrous metals (e.g. CuNi alloys, bronze, hard solders) are potentially suitable, provided that the water content in the system is at a minimum (< 1000 ppm), a system design that corresponds with typical ammonia practise is recommended nonetheless.

As lubricant mineral oils or (preferred) poly-alpha olefin can be used. As mentioned before the portion of DME creates improved oil solubility and a partial miscibility. Besides this the relatively low liquid density and an increased concentration of DME in the oil, positively influences the oil circulation. PAG oils would be fully or partly miscible with R723 for typical applications but are not recommended for reasons of the chemical stability and high solubility in the compressor crankcase (strong vapour development in the bearings).

Tests have shown that the heat transfer coefficient at evaporation and high heat flux is improved in systems with R723 and mineral oil than when using  $\text{NH}_3$  with mineral oil.

Further characteristics are toxicity and flammability. By means of the DME content, the ignition point in air diminishes from 15 to 6% but. Despite of this, the azeotrope still

remains in the safety group B2, but may receive a different classification in case of a revised assessment.

### Resulting layout criteria

The experiences made with the  $\text{NH}_3$  compact systems described above can be used in the plant technology. However, adjustments in the component layout are necessary under consideration of the higher mass flow. Besides a suitable selection of the evaporator and the expansion valve a very stable superheat control must be ensured. Due to the improved oil solubility "wet operation" can have considerable negative results when compared to  $\text{NH}_3$  systems with non-soluble oil.

With regards to safety regulations the same criteria apply to installation and operation as in the case of  $\text{NH}_3$  plants.

Suitable compressors are special  $\text{NH}_3$  versions which possibly have to be adapted to the mass flow conditions and to the continuous oil circulation. An oil separator is usually not necessary with reciprocating compressors.

**Bitzer  $\text{NH}_3$  reciprocating compressors are suitable for R723 in principle. An individual selection of specifically adapted compressors is possible on demand.**

## R290 (Propane) as substitute for R502 and R22

R290 (propane) can also be used as a substitute refrigerant. As it is an organic compound (hydrocarbon) it does not have an ozone depletion potential and a negligible direct global warming effect. To take into consideration however, is a certain contribution to summer smog.

The pressure levels and the refrigerating capacity are similar to R22 and the temperature behaviour is as favourable as with R134a.

There are no particular material issues. In contrast to  $\text{NH}_3$  copper materials are also suitable, so that semi-hermetic and hermetic compressors are possible. The mineral oils usually found in a HCFC system can be used here as a lubricant over a wide application range.

Refrigeration plants with R290 have been in operation world-wide for many years, mainly in the industrial area – it is a "proven" refrigerant.

Meanwhile R290 is also used in smaller compact systems with low refrigerant charges like residential A/C units and heat pumps. Furthermore, a rising trend can be seen in its use with commercial refrigeration systems and chillers.

Propane is offered also as a mixture with Isobutane (R600a) or Ethan (R170). This should obtain a good performance match with halocarbon refrigerants. Pure Isobutane is mostly intended as a substitute for R12 in small plants (preferably domestic refrigerators).

The disadvantage of hydrocarbons is the high flammability, and therefore been classified as refrigerants of "Safety Group A3". With the normal refrigerant charge found in commercial plants this means that the system must be designed according to "flame-proof" regulations.

The use of semi-hermetic compressors in so called "hermetically sealed" systems is in this case subject to the regulations for hazardous zone 2 (only seldom and short term risk). The demands for the safety technology

include special devices to protect against excess pressures and special arrangements for the electrical system. In addition measures are required to ensure hazard free ventilation to effectively prevent a flammable gas mixture occurring in case of refrigerant leakage.

The design requirements are defined by standards (e.g. EN378) and may vary in different countries. For systems applied within the EU an assessment according to the EC Directive 94/9/EC (ATEX) may become necessary as well.

With open compressors this will possibly lead to a classification in zone 1. Zone 1 demands, however, electrical equipment in special flame-proof design.

### Resulting design criteria

Apart from the measures mentioned above, propane plants require practically no special features in the medium and low temperature ranges compared with a usual (H)CFC and HFC system. When sizing components consideration should however be given to the relatively low mass flow (approximately 55 to 60% compared to R22). An advantage in connection with this is the possibility to greatly reduce the refrigerant charge.

On the thermodynamic side an internal heat exchanger between the suction and liquid line is recommended as this will improve the refrigerating capacity and COP.

Owing to the particularly high solubility of R290 (and R1270) in common lubricants, BITZER R290/R1270 compressors are charged with a special oil of a high viscosity index and particularly good tribological properties.

In connection to this, an internal heat exchanger is also an advantage as it leads to higher oil temperatures thus to lower solubility with the result of an improved viscosity.

Due to the very favourable temperature behaviour (Fig. 26/1), single stage compressors can be used down to approximately -40°C evaporation temperature. R290 could then also be considered as an alternative for some of the HFC blends.

**A range of semi-hermetic reciprocating compressors and CS. compact screws is available for R290. Due to the individual requirements a specifically equipped compressor version is offered. Inquires and orders need a distinctive indication to R290. The handling of the**

**order does include an individual agreement between the contract partners. Open reciprocating compressors are also available for R290, together with a comprehensive program of flame-proof accessories which may be required.**

### Conversion of existing plants with R22 or HFC

Due to the flame-proof protection measures required for an R290 plant, it would appear that a conversion of existing plants is only possible in exceptional cases.

They are limited to systems, which can be modified to meet the corresponding safety regulations with an acceptable effort.

### Supplementary BITZER information concerning the use of R290

- Technical Information KT-660  
"Application of Propane and Propylene with semi-hermetic compressors"

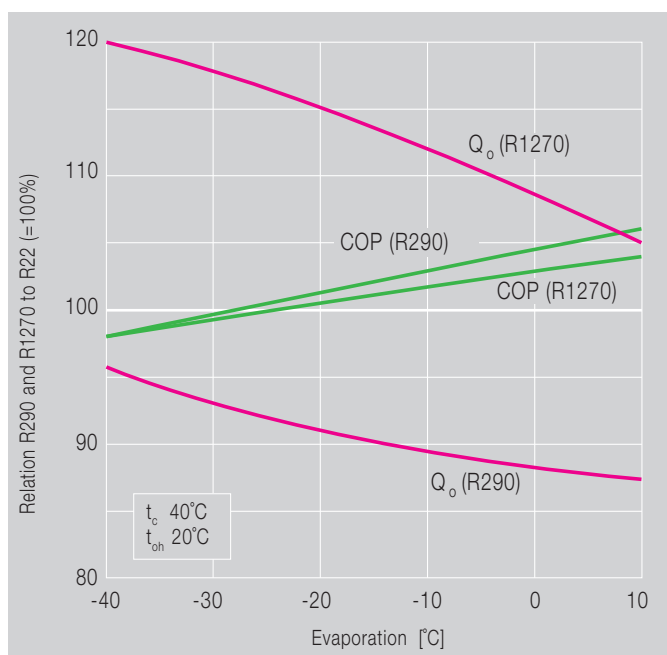

Fig. 27 R290/R1270/R22 – comparison of performance data of a semi-hermetic compressor

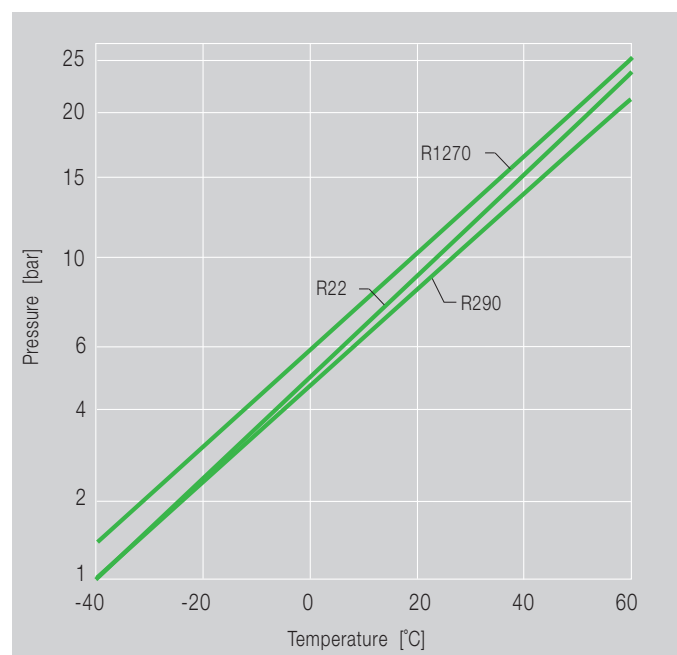

Fig. 28 R290/R1270/R22 – comparison of pressure levels

### Propylene (R1270) as an alternative to Propane

For some time there has also been increasing interest in using propylene (propene) as a substitute for R22 or HFC. Due to its higher volumetric refrigerating capacity and lower boiling temperature (compared to R290) applications in medium and low temperature systems, e.g. liquid chillers for supermarkets, are of particular interest. On the other hand, higher pressure levels (> 20%) and discharge gas temperatures have to be taken into consideration, thus restricting the possible application range.

Material compatibility is comparable with propane, as is the choice of lubricants.

Propylene is also easily inflammable and belongs to the A3 group of refrigerants. The same safety regulations are therefore to be observed as with propane (page 30).

Due to the chemical double bond propylene is relatively reaction friendly, which means

that there is a danger of polymerization at high pressure and temperature levels. Tests carried out by hydrocarbon manufacturers and stability tests in real applications show that reactivity in refrigeration systems is practically non-existent. Doubts have occasionally been mentioned in some literature regarding propylene's possible carcinogenic effects. These assumptions have been disproved by appropriate studies.

#### Resulting design criteria

With regard to system technology, experience gained from the use of propane can widely be applied to propylene. However, component dimensions have to be altered due to higher volumetric refrigerating capacity (Fig. 27). The compressor displacement is correspondingly lower and therefore also the suction and high pressure volume flows. Because of higher vapour density the mass flow is almost the same as for R290. As liquid density is nearly identical the same applies for the liquid volume in circulation.

As with R290 the use of an internal heat exchanger between suction and liquid lines is of advantage. However, due to R1270's higher discharge gas temperature restrictions are partly necessary.

**A range of semi-hermetic reciprocating compressors and CS. compact screws is available for R1270. Due to the individual requirements a specifically equipped compressor version is offered.**

**Inquires and orders need a distinctive indication to R1270. The handling of the order does include an individual agreement between the contract partners. Open reciprocating compressors are also available for R1270, together with a comprehensive program of flame-proof accessories which may be required.**

#### Supplementary BITZER information concerning the use of R1270

- **Technical Information KT-660**  
**“Application of Propane and Propylene with semi-hermetic compressors”**



### Carbon Dioxide R744 (CO<sub>2</sub>) as an alternative refrigerant and secondary fluid

CO<sub>2</sub> has had a long tradition in the refrigeration technology reaching far into the 19<sup>th</sup> century. It has no ozone depleting potential, a negligible direct global warming potential (GWP = 1), is chemically inactive, non-flammable and not toxic in the classical sense. That is why CO<sub>2</sub> is not subjected to the stringent demands regarding containment as apply for HFCs (F-Gas Regulation), and flammable or toxic refrigerants. However, compared to HFCs the lower practical limit in air has to be considered. For closed rooms this may require special safety and detection systems.

CO<sub>2</sub> is also low in cost and there is no necessity for recovery and disposal. In addition, it has a very high volumetric refrigerating capacity, which depending on operating conditions equates to approx. 5 – 8 times more than R22 and NH<sub>3</sub>.

Above all, the safety relevant characteristics were an essential reason for the initial widespread use. The main focus for applications were marine refrigeration systems, for example. With the introduction of the "(H)CFC

Safety Refrigerants", CO<sub>2</sub> became less popular and since the 1950's had nearly disappeared.

The main reasons for that are its relatively unfavourable thermodynamic characteristics for usual applications in refrigeration and air-conditioning. The discharge pressure with CO<sub>2</sub> is extremely high and the critical temperature at 31°C (74 bar) is very low. Depending on the heat source temperature at the high pressure side transcritical operations with pressures beyond 100 bar are required. Under these conditions, the energy efficiency is often lower compared to the classic vapour compression process (with condensation), and therefore the indirect global warming effect is suitably higher.

Nonetheless, there is a range of applications in which CO<sub>2</sub> can be used very economically and with favourable Eco-Efficiency. For example, these include subcritically operated cascade plants, but also transcritical systems, in which the temperature glide on the high pressure side can be used advantageously, or the system conditions permit subcritical operation for long periods. In this connection it must also be noted that the heat transfer coefficients of CO<sub>2</sub> are considerably higher than of other refrigerants – with the potential of very low

temperature differences in evaporators, condensers, and gas coolers. Moreover, the necessary pipe dimensions are very small, and the influence of the pressure drop is comparably low. In addition, when used as a secondary fluid, the energy demand for circulation pumps is extremely low.

In the following section, a few examples of subcritical systems and the resulting design criteria are described. An additional section provides details on transcritical applications.

#### Subcritical applications

From energy and pressure level points of view, very beneficial applications can be seen for industrial and larger commercial refrigeration plants. For this, CO<sub>2</sub> can be used as a secondary fluid in a cascade system and if required, in combination with a further booster stage for lower evaporating temperatures (Fig. 30/1).

The operating conditions are always subcritical which guarantees good efficiency levels. In the most favourable application range (approx. -10 to -50°C), pressures are still on a level where already available components or items in development, e.g. for R410A, can be matched with acceptable effort.

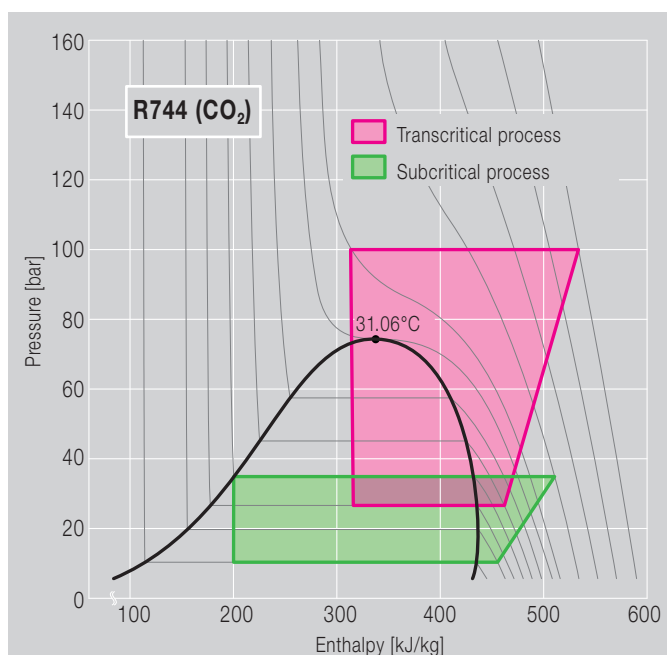

Fig. 29/1 R744(CO<sub>2</sub>) – pressure/enthalpy diagram

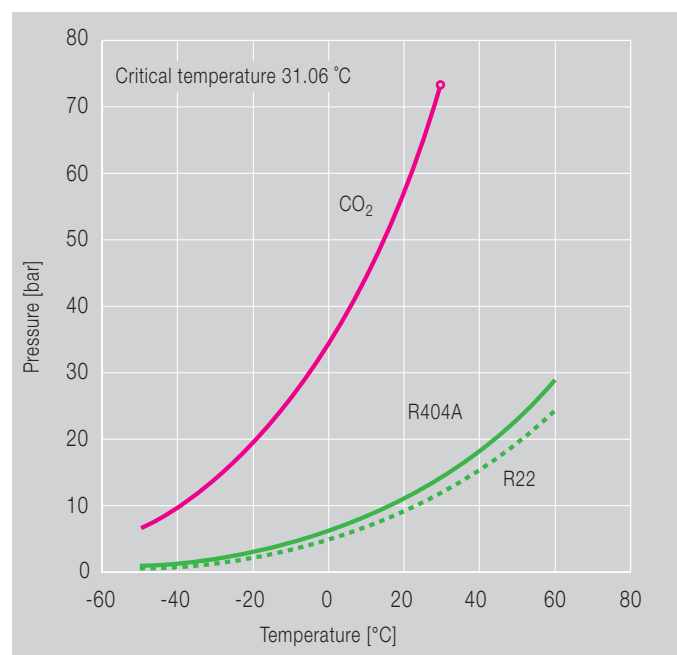

Fig. 29/2 R744(CO<sub>2</sub>)/R22/R404A – comparison of pressure levels

**Resulting design criteria**

For the high temperature side of such a cascade system, a compact cooling unit can be used, whose evaporator serves on the secondary side as the condenser for CO<sub>2</sub>. Chlorine-free refrigerants are suitable such as NH<sub>3</sub>, HCs or HFCs, HFO and HFO/HFC blends.

With NH<sub>3</sub> the cascade heat exchanger should be designed so that the dreaded build-up of ammonium carbonate is prevented in the case of leakage. This technology has been applied in breweries for a long time.

A secondary circuit for larger plants with CO<sub>2</sub> could be constructed utilising, to a wide extent, the same principles for a low pressure pump circulating system, as is often used with NH<sub>3</sub> plants. The essential difference exists therein, that the condensing of the CO<sub>2</sub> results in the cascade cooler, and the receiver tank (accumulator) only serves as a supply vessel.

The extremely high volumetric refrigerating capacity of CO<sub>2</sub> (latent heat through the changing of phases) leads to very low mass flow rates and makes it possible to use small cross sectional pipe and minimal energy needs for the circulating pumps.

For the combination with a further compression stage, e.g. for low temperatures, there are different solutions.

Fig. 30/1 shows a variation with an additional receiver where one or more Booster compressors will pull down to the necessary evaporation pressure. Likewise, the discharge gas is fed into the cascade cooler, condenses and then carried over to the receiver (MT). The feeding of the low pressure receiver (LT) is achieved by a level control device. Instead of classical pump circulation the booster stage can also be built as a so-called LPR system.

The circulation pump is thus not necessary but the number of evaporators is then limited with a view to an even distribution of the injected CO<sub>2</sub>.

In the case of a system breakdown where a high rise in pressure could occur, safety valves can vent the CO<sub>2</sub> to the atmosphere with the necessary precautions.

As an alternative to this, additional cooling units for CO<sub>2</sub> condensation are also used where longer shut-off periods can be bridged without a critical pressure increase.

For systems in commercial applications a direct expansion version is possible as well.

Supermarket plants with their usually widely branched pipe work offer an especially good potential in this regard. The medium temperature system is then carried out in a conventional design or with a secondary circuit and for low temperature application combined with a CO<sub>2</sub> cascade system (for subcritical operation). A system example is shown in Fig. 30/2.

For a general application, however, not all requirements can be met at the moment. It is worth considering that system technology changes in many respects and specially adjusted components are necessary to meet the demands.

The compressors, for example, must be properly designed because of the high vapour density and pressure levels (particularly on the suction side). There are also specific requirements with regard to materials. Furthermore only highly dehydrated CO<sub>2</sub> must be used.

High demands are made on lubricants as well. Conventional oils are mostly not miscible and therefore require costly measures to return the oil from the system. On the other hand, a strong viscosity reduction with the use of a miscible and highly soluble POE must be considered.

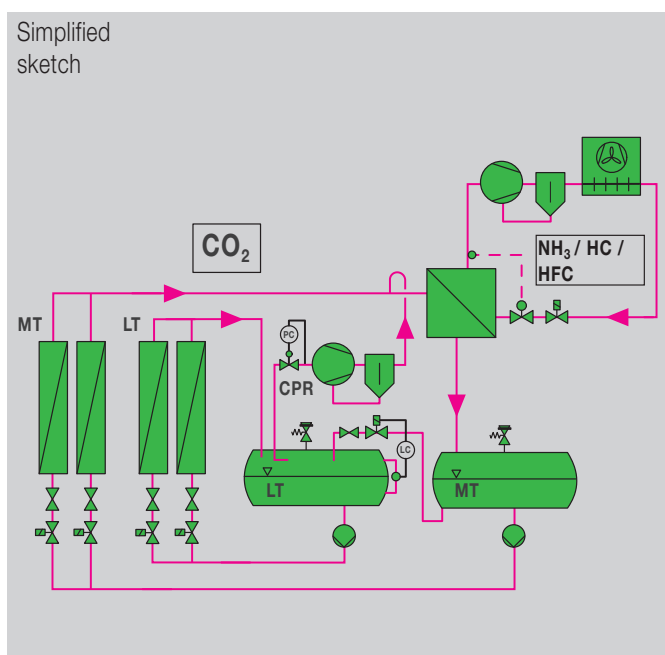

Fig. 30/1 Cascade system with CO<sub>2</sub> for industrial applications

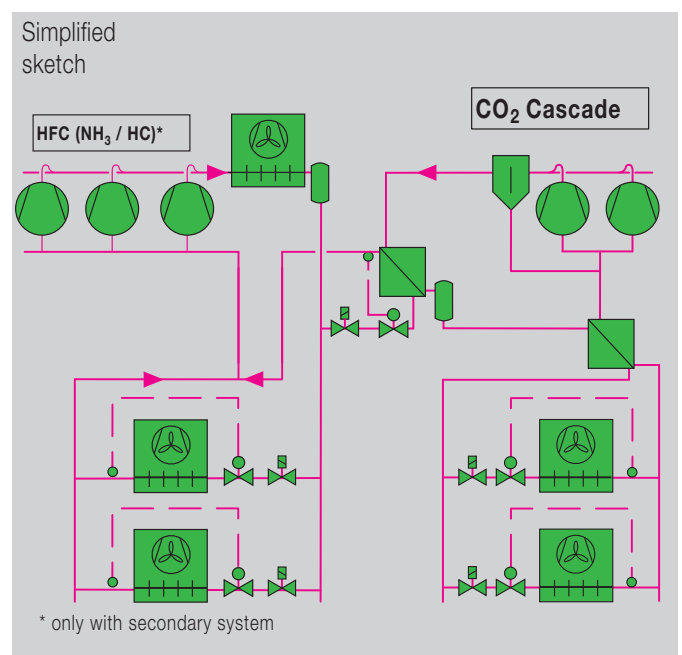

Fig. 30/2 Conventional refrigeration system combined with CO<sub>2</sub> low temperature cascade

**For subcritical CO<sub>2</sub> applications  
BITZER offers two series of special  
compressors.**

**Supplementary BITZER information  
concerning compressor selection for  
subcritical CO<sub>2</sub> systems**

❑ **Brochure KP-120**

**Semi-hermetic reciprocating compressors for subcritical CO<sub>2</sub> application (LP/HP standstill pressures up to 30/53 bar)**

❑ **Brochure KP-122**

**Semi-hermetic reciprocating compressors for subcritical CO<sub>2</sub> application (LP/HP standstill pressures up to 100 bar)**

❑ **Additional publications on request**

**Transcritical applications**

Transcritical processes are characterized in that the heat rejection on the high pressure side proceeds isobar but not isotherm. Contrary to the condensation process during subcritical operation, gas cooling (desuperheating) occurs, with corresponding temperature glide. Therefore, the heat exchanger is described as gas cooler. As long as operation remains above the critical pressure (74 bar), only high-density vapour will be transported. Condensation only takes place after expansion to a lower pressure level – e.g. by interstage expansion in an intermediate pressure receiver. Depending on the temperature curve of the heat sink, a system designed for transcritical operation can also be operated subcritically, whereby the efficiency is better under these conditions. In this case, the gas cooler becomes the condenser.

Another feature of transcritical operation is the necessary control of the high pressure to a defined level. This "optimum pres-

sure" is determined as a function of gas cooler outlet temperature by means of balancing between the highest possible enthalpy difference and simultaneous minimum compression work. It must be adapted to the relevant operating conditions using an intelligent modulating controller (see system example, Fig. 31).

As described above, under purely thermodynamic aspects, the transcritical operating mode appears to be unfavourable in terms of energy efficiency. In fact, this is true for systems with a relatively high temperature level of the heat sink on the high-pressure side. However, additional measures can be taken for improving efficiency, such as the use of parallel compression (economiser system) and/or ejectors or expanders for recovering the throttling losses during expansion of the refrigerant. Apart from that, there are application areas in which a transcritical process is advantageous in energy demand. These include heat pumps for sanitary water, or drying processes. With the usually very high temperature gradients between the discharge temperature at the gas cooler intake and the heat sink intake temperature, a very low gas temperature outlet is achievable. This is positively influenced by the temperature glide curve and the relatively high mean temperature difference between CO<sub>2</sub> vapour and secondary fluid. The low gas outlet temperature leads to a particularly high enthalpy difference, and therefore to a high system COP.

Low-capacity sanitary water heat pumps are already manufactured and used in large quantities. Plants for medium to higher capacities (e.g. hotels, indoor swimming pools) are still in the development and introductory phase.

Apart from these specific applications, there is also a range of developments for the classical areas of refrigeration and air-conditioning. This also covers supermarket

refrigeration plants, for example. Meanwhile installations with parallel compounded compressors are in operation to a larger scale. They are predominantly booster systems where medium and low temperature circuits are connected together (without heat exchanger). The operating experience and the determined energy costs show promising results. However, the investment costs are still considerably higher than for classical plants with HFCs and direct expansion.

On the one hand, the reasons for the favourable energy costs lie in the high degree of optimized components and the system control, and also in the previously described advantages regarding heat transfer and pressure drop. On the other hand, these installations are preferably used in climate zones permitting very high running times in subcritical operation due to the annual ambient temperature profile.

For increasing the efficiency of CO<sub>2</sub> supermarket systems and for using them in warmer climate zones, the technologies described above using parallel compression and/or ejectors are increasingly used.

Insofar, but also in view of the very demanding technology and the high requirements placed on the qualification of planners and service personnel, CO<sub>2</sub> technology cannot be regarded as a general replacement for plants using HFC refrigerants.

**Resulting design criteria**

Detailed information on this topic would go beyond the scope of this publication. In any case, the system and control techniques are substantially different from conventional plants. Already when considering pressure levels as well as volume and mass flow ratios specially developed components, controls, and safety devices as well as suitably dimensioned pipework must be provided.

The compressor technology is particularly demanding. The special requirements result in a completely independent approach. For example, this involves design, materials (bursting resistance), displacement, crank gear, working valves, lubrication system, as well as compressor and motor cooling. Hereby, the high thermal load severely limits the application for single-stage compression. Low temperature cooling requires 2-stage operation, whereby separate high and low pressure compressors are particularly advantageous with parallel compound-ed systems.

The criteria mentioned above in connection with subcritical systems apply to an even higher degree for lubricants.

Further development is necessary in many areas, and for most applications, transcritical CO<sub>2</sub> technology cannot yet be regarded as state-of-the-art.

**For transcritical CO<sub>2</sub> applications, BITZER offers a wide range of special compressors. Their use is aimed at specific applications, therefore individual examination and assessment are required.**

**Supplementary BITZER information concerning compressor selection for transcritical CO<sub>2</sub>-systems**

- Brochure KP-130
- Semi-hermetic reciprocating compressors for transcritical CO<sub>2</sub> application
- Additional publications upon request

**CO<sub>2</sub> in mobile air-conditioning systems**

Within the scope of the long-discussed measures for reducing direct refrigerant emissions, and the ban on the use of R134a in MAC systems\* within the EU, the development of CO<sub>2</sub> systems has been pursued intensively since several years.

At the first glance, efficiency and therefore the indirect emissions from CO<sub>2</sub> systems under typical ambient conditions appear to be relatively unfavourable. But it must be considered that present R134a systems are less efficient than stationary plants of the same capacity. The reasons for this lie in the specific installation conditions and the relatively high pressure losses in pipe-work and heat exchangers. With CO<sub>2</sub>,

pressure losses have significantly less influence. Moreover, system efficiency is further improved by the high heat transfer coefficients in the heat exchangers.

This is why optimized CO<sub>2</sub> air-conditioning systems are able to achieve efficiencies that are comparable to those of R134a. Regarding the usual leakage rates of such systems, a more favourable balance is obtained in terms of TEWI.

From today's viewpoint, it is not yet possible to make a prediction as to whether the CO<sub>2</sub> technology can in the long run prevail in this application. Certainly, this also depends on experiences with "Low GWP" refrigerants (page 11) which in the meantime are partially introduced by the automotive industrie. Hereby, other aspects such as operating safety, costs, and global logistics will play an important role.

\* See page 11 for further information.

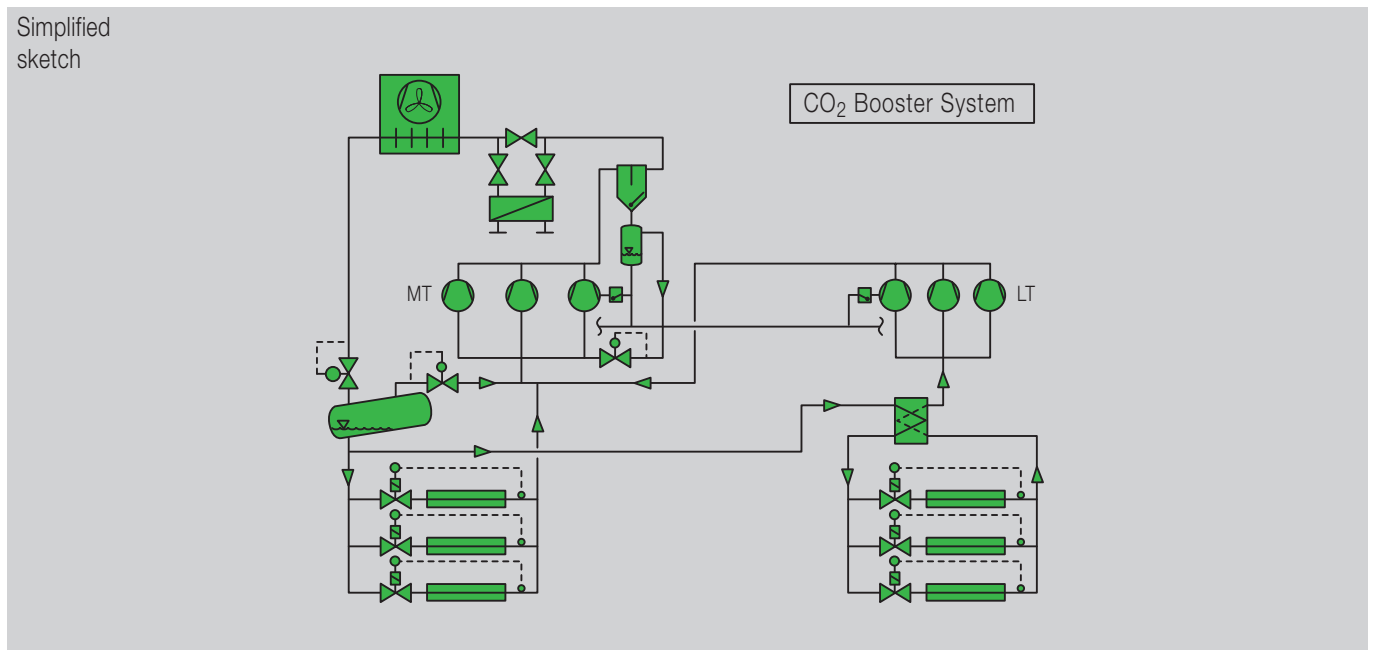

Fig. 31 Example of a transcritical CO<sub>2</sub> Booster System

## R124 and R142b as substitutes for R114 and R12B1

Instead of the refrigerants R114 and R12B1 predominately found in the past in high temperature heat pumps and crane cabin A/C installations, the HCFC R124 and R142b can be used as alternatives in new installations.

With these gases it is also possible to use long proven lubricants, preferably mineral oils and alkyl benzenes with high viscosity.

Because of the Ozone Depleting Potential, the use of these refrigerants must only be regarded as an interim solution. In the EU member states, the application of HCFCs is no longer allowed. For R124 and R142b the same restrictions are valid as for R22 (page 8). The flammability of R142b should also be considered with the resulting safety implications (safety group A2).

### Resulting design criteria/ Converting existing plants

In comparison to R114 the boiling temperatures of the alternatives are lower (approx. -10°C) which results in larger differences in the pressure levels and volumetric refrigerating capacities. This leads to stronger limitations in the application range concerning high evaporation and condensing temperatures.

A conversion of an existing installation will in most cases necessitate the exchanging of the compressor and regulating devices. Owing to the lower volume flow (higher volumetric refrigerating capacity), possible adjustments to the evaporator and the suction line will be required.

**Over the previous years BITZER compressors have been found to be well suited with R124 and R142b in actual installations. Depending on performance data and compressor type modifications are necessary, however. Performance data including further design instructions are available on request.**

## Chlorine free substitutes for special applications

Due to the limited markets for systems with extra high and low temperature applications, the requirements for the development of alternative refrigerants and system components for these areas has not been so great.

In the meantime a group of alternatives for the CFC R114 and Halon R12B1 (high temperature), R13B1, R13 and R503 (extra low temperature) were offered as the replacements. With closer observations it has been found that the thermodynamic properties of the alternatives differ considerably from the previously used substances. This can cause costly changes especially with the conversion of existing systems.

### Alternatives for R114 and R12B1

R227ea and R236fa are considered suitable substitutes even though they may no longer be used in new installations in the EU from 2020, due to their relatively high GWP.

R227ea cannot be seen as a full replacement. Recent research and field tests have shown favourable results, but with normal system technology the critical temperature of 102°C limits the condensing temperatures to about 85..90°C.

R236fa provides the more favourable conditions at least in this regard – the critical temperature is above 120°C. A disadvantage, however, is the smaller volumetric refrigerating capacity. This is similar to R114 and with that 40% below the performance of R124 which is widely used for extra high temperature applications today.

Refrigerant R600a (Isobutane) will be an interesting alternative where the safety regulations allow the use of hydrocarbons (safety group A3). With a critical temperature of 135°C, condensing temperatures of 100°C and more are within reach.

The volumetric refrigerating capacity is almost identical to R124.

The "Low GWP" refrigerant R1234ze(E) can also be regarded as a potential candidate for extra high temperature applications. Compared to R124, its cooling capacity is higher by 10 to 20% and its pressure level by about 25%. At an identical refrigerating capacity, the mass flow differs only slightly. Its critical temperature is 107°C, which would enable an economical operation up to a condensing temperature of about 90°C. However, like R1234yf, R1234ze(E) is mildly flammable and therefore classified in the new safety group A2L. The corresponding safety regulations must be observed.

However, until now no sufficient operating experience is available, which is why an assessment of the suitability of this refrigerant for long-term use is not yet possible.

For high temperature heat pumps in the process technologie and special applications in the field of high temperatures DuPont has presented an HFO based refrigerant called DR-2.

The critical temperature is at 171°C, the boiling temperature at 33.4°C. This enables an operation at condensing temperatures far above 100°C for which only purpose-built compressors and system components can be used.

DR-2 has a GWP < 10 but is not flammable according to tests carried out so far. Therefore a classification in safety group A1 can be expected.

A more detailed evaluation is not yet possible with respect to the chemical stability of the refrigerant and of the lubricants at the very high temperatures and the usually very long operating cycles of such systems. The special applications also include systems for power-heat coupling – the so-called **"Organic Rankine Cycle" (ORC)**, which become increasingly important. In addition to DR-2 as a potentially suitable operating fluid, a series of other substances are also possible, depending on the temperature level of the heat source and the heat sink.

They include R245ca (GWP<sub>100</sub> = 1030) having a critical temperature of 154°C, which like DR-2 is also suitable as refrigerant for chillers with large centrifugal compressors. In addition Solvay offers suitable refriger-



ants containing the base component R365mfc for ORC applications. A product with the trade name Solkatherm SES36 already presented several years ago contains perfluoropolyether as a blend component. It is an azeotrope having a critical temperature of 178°C. Meanwhile two zeotropic blends containing R365mfc and R227ea have been developed whose critical temperatures are 177°C and 182°C, due to different mixing ratios. They are available under the trade names Solkatherm SES24 and SES30.

In ORC systems zeotropic behavior may be advantageous. In the case of single-phase heat sources and heat sinks the temperature difference at the so-called "pitch point" can be raised by the gliding evaporation and condensation. This leads to improved heat transmission due to the higher driving average temperature difference.

**As an expander for ORC systems screw and scroll compressors can be adapted in their construction accordingly. For several years BITZER has been involved in various projects and has already gained important knowledge with this technology and experience in design and application.**

**A comprehensive description of ORC systems would go beyond the scope of this Refrigerant Report. Further information is available upon request**

### Alternatives for R13B1

Besides R410A, ISCEON MO89 (DuPont) can be regarded as potential R13B1 substitute. With R410A a substantially higher discharge gas temperature is to be considered when compared to R13B1 which restricts the application range even in 2-stage compression systems to a greater extent.

ISCEON MO89 is a mixture of R125 and R218 with a small proportion of R290. Due to the properties of the two main components, density and mass flow are relatively high and discharge gas temperature is very low. Liquid subcooling is of particular advantage.

Both of the mentioned refrigerants have relatively high pressure levels and are therefore limited to 40 through 45°C condensing temperature with the usually applied 2-stage compressors. They also show less capacity

than R13B1 at evaporating temperatures below -60°C. In addition to this, the steep fall of pressure limits the application at very low temperatures and may require a change to a cascade system with for example R23 in the low temperature stage.

Lubrication and material compatibility are assessed as being similar to the other HFC blends.

### Alternatives for R13 and R503

The situation is more favourable with these substances as R23 and R508A/R508B can already replace R13 and R503. Refrigerant R170 (Ethane) is also suitable when the safety regulations allow the use of hydrocarbons (safety group A3).

Due to the partly steeper pressure curve of the alternative refrigerants and the higher discharge gas temperature of R23 compared with R13, differences in performance and application ranges for the compressors must be considered. Individual adaptation of the heat exchangers and controls is also necessary.

As lubricants for R23 and R508A/B, polyol ester oils are suitable, but these must be matched for the special requirements at extreme low temperatures.

R170 has also good solubility with conventional oils, however an adaptation to the temperature conditions will be necessary.

**BITZER has carried out investigations and also collected experiences with several of the substitutes mentioned, performance data and instructions are available on request.**

**Due to the individual system technology for these special installations, consultation with BITZER is necessary.**

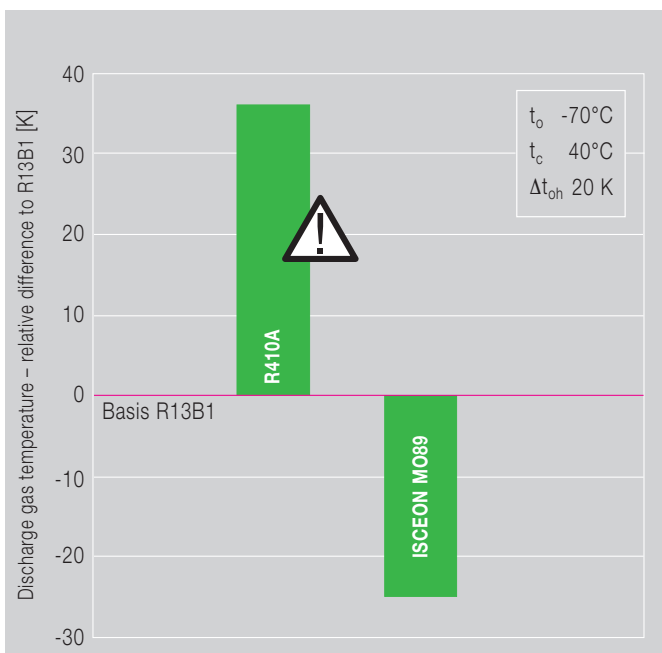

Fig. 32 R13B1/HFC alternatives – comparison of discharge gas temperatures of a 2-stage compressor

Refrigerant type	Composition (Formula)	Substitute / Alternative for	Application range	ODP [R11=1,0]	GWP <sub>(100a)</sub> <sup>⑤</sup> <sup>⑥</sup> [CO <sub>2</sub> =1,0]	Safety group <sup>④</sup>	Practical limit [kg/m <sup>3</sup> ] <sup>⑤</sup>
<b>HCFC-Refrigerants</b>							
R22	CHClF <sub>2</sub>	R502 (R12 <sup>①</sup> )	see page 40	0.055	1810	A1	0.3
R124	CHClFCF <sub>3</sub>	R114 <sup>①</sup> , R12B1		0.022	609	A1	0.11
R142b	CClF <sub>2</sub> CH <sub>3</sub>			0.065	2310	A2	0.066
<b>HFC Single-component Refrigerants</b>							
R134a	CF <sub>3</sub> CH <sub>2</sub> F	R12 (R22 <sup>①</sup> )	see page 40	0	1430	A1	0.25
R152a	CHF <sub>2</sub> CH <sub>3</sub>	mainly used as part components for blends			124	A2	0.027
R125	CF <sub>3</sub> CHF <sub>2</sub>				3500	A1	0.39
R143a	CF <sub>3</sub> CH <sub>3</sub>				4470	A2	0.056
R32	CH <sub>2</sub> F <sub>2</sub>				675	A2L	0.061
R227ea	CF <sub>3</sub> -CHF-CF <sub>3</sub>				R12B1, R114 <sup>①</sup>	3220	A1
R236fa	CF <sub>3</sub> -CH <sub>2</sub> -CF <sub>3</sub>	R114	9810	A1		0.59	
R23	CHF <sub>3</sub>	R13 (R503)		14800	A1	0.68	
<b>HFC Blends</b>							
R404A	R143a/125/134a	R22 (R502)	see page 40	0	3922	A1	0.52
R507A	R143a/125				3985	A1	0.53
R407A	R32/125/134a				2107	A1	0.33
R407F	R32/125/134a				1825	A1	0.29
R422A	R125/134a/600a				3143	A1	0.29
R437A	R125/134a/600/601	R12 (R500)			1805	A1	0.08
R407C	R32/125/134a	R22	1774	A1	0.31		
R417A	R125/134a/600		2346	A1	0.15		
R417B	R125/134a/600		2920	A1	0.07		
R422D	R125/134a/600a		2729	A1	0.26		
R427A	R32/125/143a/134a		2138	A1	0.28		
R438A	R32/125/134a/600/601a		2264	A1	0.08		
R410A	R32/125	R22 <sup>①</sup> (R13B1 <sup>②</sup> )	2088	A1	0.44		
ISCEON MO89	R125/218/290	R13B1 <sup>②</sup>	3805	N/A	N/A		
R508A	R23/116	R503	13214	A1	0.23		
R508B	R23/116		13396	A1	0.2		
<b>HFO and HFO/HFCBlends</b>							
R1234yf	CF <sub>3</sub> CF=CH <sub>2</sub>	R134a	see page 40	0	4	A2L	0.058
R1234ze(E)	CF <sub>3</sub> CH=CHF				7	A2L	N/A
R513A (XP10)	R1234yf/134a				631	A1	0.35
R450A (N-13)	R1234ze(E)/134a				601	A1	N/A
R448A (N-40)	R32/125/1234yf/1234ze(E)/134a	R404A, R507A	1386	A1	N/A		
R449A (XP40)	R32/125/1234yf/134a		1397	A1	N/A		
<b>Halogen free Refrigerants</b>							
R717	NH <sub>3</sub>	R404A (R22)	see page 41	0	0	B2	0.00035
R723	NH <sub>3</sub> /R-E170	R404A (R22)			8	B2	N/A
R600a	C <sub>4</sub> H <sub>10</sub>	R134a <sup>①</sup>			3	A3	0.011
R290	C <sub>3</sub> H <sub>8</sub>	R404A (R22)			3	A3	0.008
R1270	C <sub>3</sub> H <sub>6</sub>	R404A (R22)			3	A3	0.008
R170 <sup>③</sup>	C <sub>2</sub> H <sub>6</sub>	R23			3	A3	0.008
R744	CO <sub>2</sub>	various	1	A1	0.07		

Fig. 33 Refrigerant properties (continued on Fig. 34)

These statements are valid subject to reservations; they are based on information published by various refrigerant manufacturers.

- ① Alternative refrigerant has larger deviation in refrigerating capacity and pressure
  - ② Alternative refrigerant has larger deviation below -60°C evaporating temperature
  - ③ Also proposed as a component in R290/600a-Blends (direct alternative to R12)
  - ④ Classification according to EN378-1 and ASHRAE 34
  - ⑤ According to EN 378-1: 2008 + A2: 2012, Annex E
  - ⑥ AR4: according to IPCC IV – time horizon 100 years – also basis for EU F-Gas Regulation 517/2014
- N/A Data not yet published.

Refrigerant type	Boiling temperature [°C]①	Temperature glide [K]②	Critical temperature [°C]①	Cond. temp. at 26 bar (abs) [°C]①	Refr. capacity [%]③	Discharge gas temp. [K]③	Schmierstoff (Verdichter)	
HCFC-Refrigerants								
R22	-41	0	96	63	80 (L)④	+35④	see page 41	
R124	-11	0	122	105	⑤	⑤		
R142b	-10	0	137	110				
HFC Single-component Refrigerants								
R134a	-26	0	101	80	97 (M)	-8		
R152a	-24	0	113	85	N/A	N/A		
R125	-48	0	66	51	N/A	N/A		
R143a	-48	0	73	56	N/A	N/A		
R32	-52	0	78	42	N/A	N/A		
R227ea	-16	0	102	96				
R236fa	-1	0	>120	117	⑤	⑤		
R23	-82	0	26	1	⑤	⑤		
HFC Blends								
R404A	-47	0.7	73	55	105 (M)	-34		
R507A	-47	0	71	54	107 (M)	-34		
R407A	-46	6.6	83	56	98 (M)	-19		
R407F	-46	6.4	83	57	104 (M)	-11		
R422A	-49	2.5	72	56	100 (M)	-39		
R437A	-33	3.6	95	75	108 (M)	-7		
R407C	-44	7.4	87	58	100 (H)	-8		
R417A	-39	5.6	87	68	97 (H)	-25		
R417B	-45	3.4	75	58	95 (M)	-37		
R422D	-45	4.5	81	62	90 (M)	-36		
R427A	-43	7.1	87	64	90 (M)	-20		
R438A	-42	6.6	80	63	88 (M)	-27		
R410A	-51	<0.2	72	43	140 (H)	-4		
ISCEON MO89	-55	4.0	70	50	⑤	⑤		
R508A	-86	0	13	-3	⑤	⑤		
R508B	-88	0	14	-3				
HFO and HFO/HFC Blends								
R1234yf	-30	0	95	82	99 (M)	-14		
R1234ze(E)	-18	0	110	92	⑤	⑤		
R513A (XP10)	-29	0	98	78	102 (M)	-7		
R450A (N-13)	-24	0.4	106	85	88 (M)	-6		
R448A (N-40)	-45	6.1	84	60	94 (M)	+12		
R449A (XP40)	-46	5	82	58	97 (M)	+12		
Halogen free Refrigerants								
R717	-33	0	133	60	100 (M)	+60		
R723 ③	-37	0	131	58	105 (M)	+35		
R600a	-12	0	135	114	N/A	N/A		
R290	-42	0	97	70	89 (M)	-25		
R1270	-48	0	92	61	112 (M)	-20		
R170	-89	0	32	3	⑤	⑤		
R744	-57⑥	0	31	-11	⑤	⑤		

Fig. 34 Refrigerant properties

① Rounded values

② Total glide from bubble to dew line – based on 1 bar (abs.) pressure. Real glide dependent on operating conditions. Approx. values in evaporator: H/M 70%; L 60% of total glide

③ Reference refrigerant for these values is stated in Fig. 33 under the nomination “Substitute for” (column 3) Letter within brackets indicates operating conditions  
 H High temp (+5/50°C)  
 M Medium temp (-10/45°C)  
 L Low temp (-35/40°C)

④ Valid for single stage compressors

⑤ Data on request (operating conditions must be given)

⑥ Triple point at 5,27 bar

Stated performance data are average values based on calorimeter tests.

### Transitional/Service refrigerants

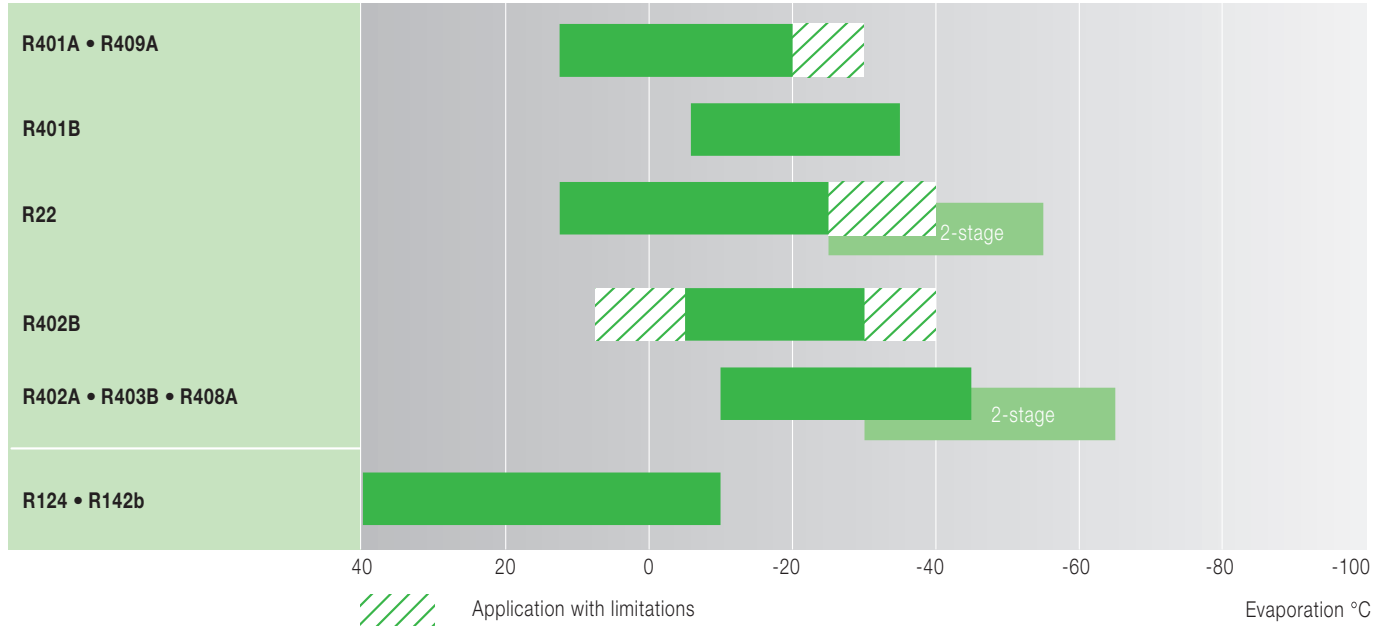

Fig. 35 Application ranges for HCFC's and Service Blends

### HFC and HFO refrigerants

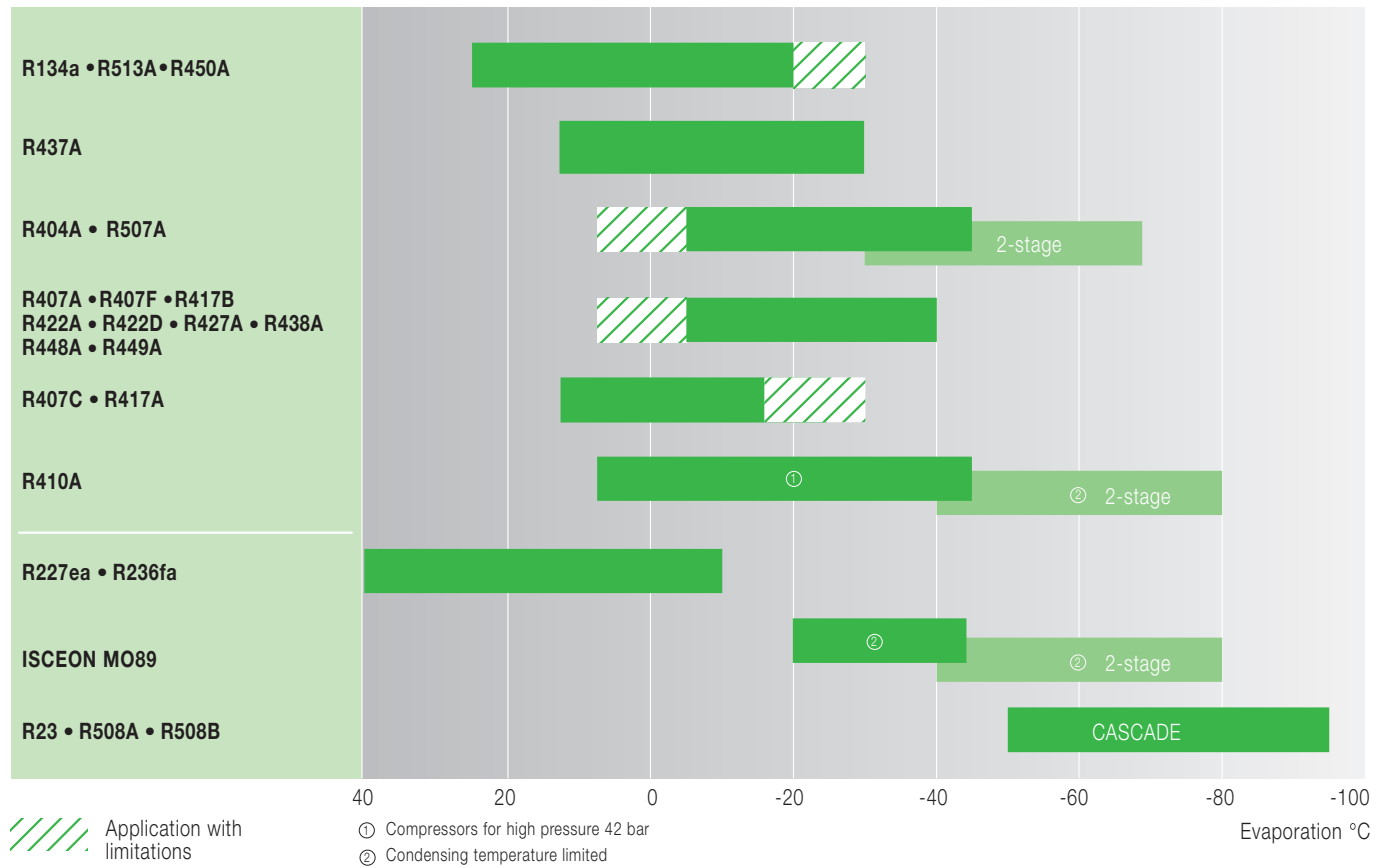

Fig. 36 Application ranges for HFC refrigerants and blends (ODP = 0)

### Halogen free refrigerants

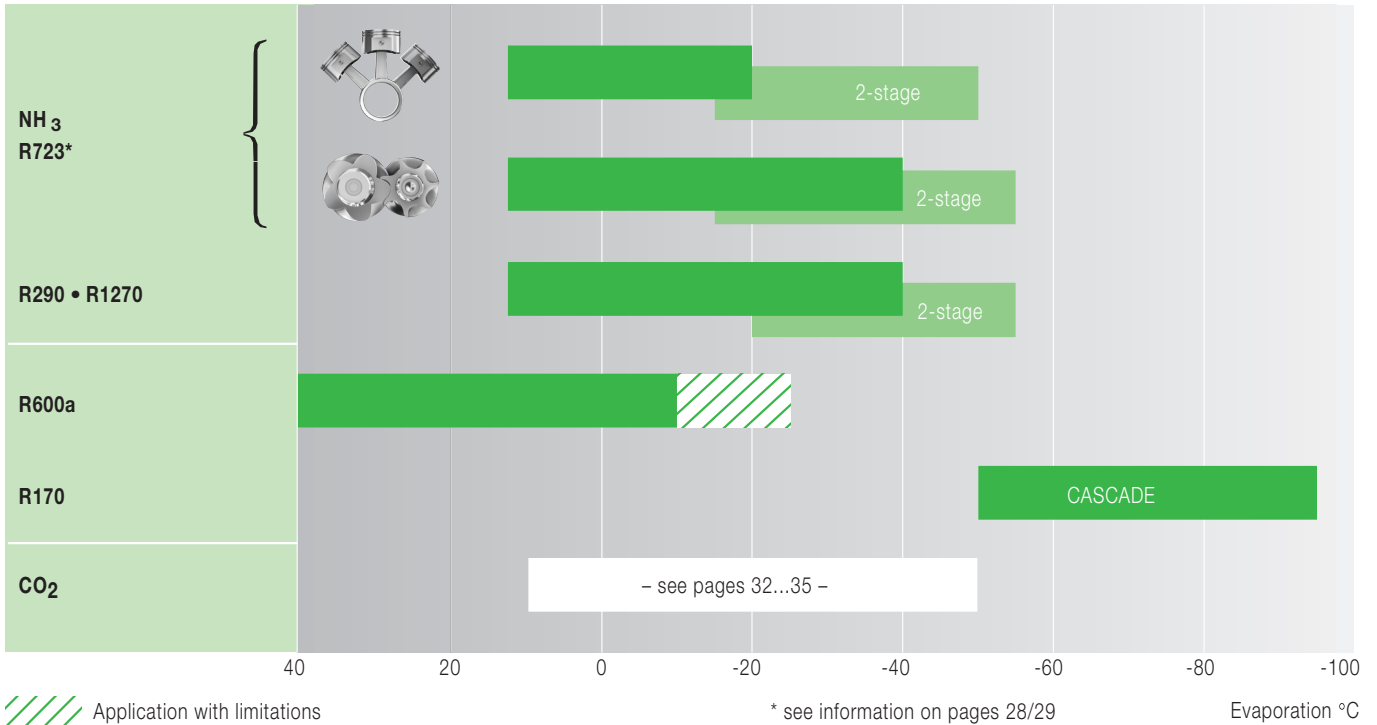

Fig. 37 Application ranges for halogen free refrigerants

### Lubricants

	Traditional oils				New lubricants			
	Mineral oil (MO)	Alkyl-benzene (AB)	Mineral oil + alkyl-benzene	Poly-alpha-olefin (PAO)	Polyol ester (POE)	Polyvinyl-ether (PVE)	Poly-glycol (PAG)	Hydro cracked mineral oil
(H)CFC	Good	Good	Good	Application with limitations	⚠ +VG			
Service blends with R22	Application with limitations	Good	Good		⚠ +VG			
HFC + blends		Application with limitations			Good	Good	⚠	
HFC/HC blends	Application with limitations	Application with limitations	Application with limitations		Good	Good		
HFO+HFO/HFC blends					AD			
Hydrocarbons	VG	Application with limitations	Application with limitations	VG	VG		⚠	
NH <sub>3</sub> • R723	Good	Application with limitations	Application with limitations	Good			⚠	Good

	Good suitability		Suitability dependant on system design		Especially critical with moisture	AD	Possible special formulation
	Application with limitations		Not suitable	VG	Possible higher basic viscosity		

Further information see pages 10/11 and explanations for the particular refrigerants.

Fig. 38 Lubricants for compressors





**Notes**

A large grid of small green dots for taking notes, consisting of 20 columns and 30 rows.

Notes

A large grid of green dots for taking notes.

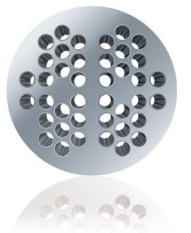



**BITZER Kühlmaschinenbau GmbH**  
Eschenbrünnelestraße 15 // 71065 Sindelfingen // Germany  
Tel +49 [0]70 31 932-0 // Fax +49 [0]70 31 932-147  
bitzer@bitzer.de // www.bitzer.de

Subject to change // 80050203 // 09.2014