



BCM2000

Bock Compressor Management

Operating instructions BCM2000

Foreword

Dear Customer,

The BCM 2000 (Bock Compressor Management) has been developed by Bock. It constitutes a compact compressor monitoring unit with logical, simple functions. The unit can be used for early detection of faults, to reduce damage and failures, and thus to increase the operating reliability and service life of your refrigerating compressor or refrigerating machine. The unit has been designed and certified only for Bock hermetic compressors. It is located in the terminal box (instead of the motor protection trigger device). All possible monitoring functions are connected and have been activated and tested in the factory. Only the control voltage has to be connected and the unit integrated in the machine control safety chain for it to be ready to operate.

QUALITY SYSTEM

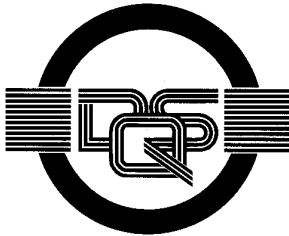

certified by DQS according to
DIN EN ISO 9001 : 2000
Reg. No. 2177



GEA Bock GmbH
Benzstraße 7
72636 Frickenhausen
Germany

Telephone +49 7022 9454 0
Fax +49 7022 9454 137
bock@gea.com
www.bock.de

All we ask of you:

Please read the information summarised for you in this manual before starting work.

It contains important instructions for safety, control, initial commissioning and troubleshooting. In addition you will find information on spare parts and accessories.

Some instructions are identified by special symbols:



WARNING! This symbol is used to indicate that inaccurate compliance or total failure to comply with the instructions could cause injury to persons or damage to the compressor or refrigerating machine.



This symbol indicates important additional instructions which you should observe during your work.

The high quality standard of Bock compressors is guaranteed also by on-going further development of the design, features and accessories. This could possibly result in nonconformities between this present manual and your unit. Please understand that it is not possible for any claims to be derived from the details, illustrations and descriptions.

Your team at
GEA Bock GmbH

Contents



Contents	Page
----------	------

● Foreword	2
● Safety instructions	4
● Technical data	4
● Structure / functions	4
● Standart settings	6
● Adjustable setting	6
● Sensor details	6
● Electrical connection	7
- General	7
- Connecting the unit	7
- Integration of additional switching and control components	9
● Checking functions	9
● Activating or bridging certain monitoring functions	10
● Reset button	11
● Error messages - information messages - emergency operation	11
- Temperature displays	12
- Oil pressure displays	12
- Compressor displays	13
- Surge guard displays	13
- Service displays	13
● Spare parts and accessories	14
● Troubleshooting	15

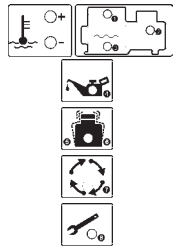
GB



Legend:

-  LED on or flashes
-  LED off

Product description

Safety

Work on the BCM 2000 may only be carried out by persons whose technical training, skills and experience together with their knowledge of pertinent regulations means that they are capable of assessing the work to be carried out and detecting any possible dangers.



Safety instructions

CAUTION HIGH-VOLTAGE CURRENT!

Only qualified electricians are allowed to handle the unit.

The monitoring unit BCM 2000 is mounted in the compressor connection box. Although the motor connection is covered, the machine must be disconnected from the mains before and during all work and when testing the machine, otherwise there is a risk of injuries.

- National safety regulations, accident prevention regulations, technical rules and other specifications must be observed.
- Compare the voltage and frequency details with the data for the local electricity mains. The unit may only be connected to the mains when the data coincide.
- The terminals of the control unit must not come into contact with the mains voltage, otherwise the unit and the monitoring sensors will be destroyed.

Technical data

Connection voltage: AC 230 V + 10% 50/60 Hz
tol. ambient temperature: -30°C ... +60°C
Relay: AC 250 V, 3A, 750 VA ind.

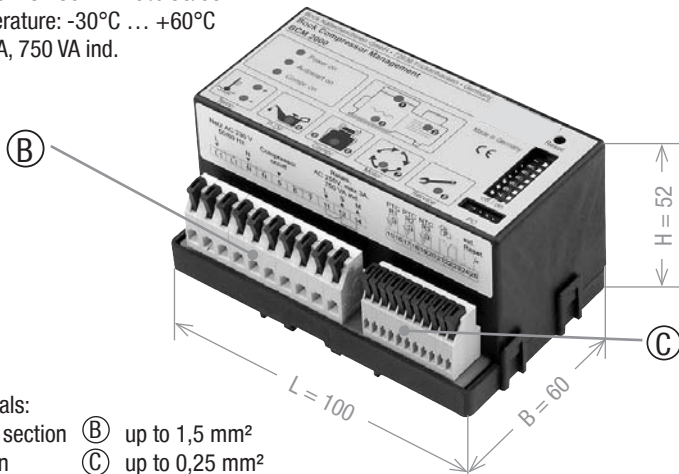

Connection terminals:

- on power supply section (B) up to 1,5 mm²
- on control section (C) up to 0,25 mm²

Structure / functions

The BCM 2000 is used solely for monitoring the operation of BOCK refrigerating compressors. All monitoring parameters have been coordinated exactly to the compressor connected up in the factory. Incoming signals are detected as status, information or error messages and processed to release, shutdown and reporting functions. The unit does not exercise any regulating function.

Product description

The unit has three main components:

- (A) - Electronic section (B) - Power supply section (C) - Control section

Altogether the unit has 8 monitoring functions: motor winding temperature, compressed gas temperature, oil temperature, oil pressure, liquid detection during start-up, compressor rotation detection, surge guard, recommended oil change.

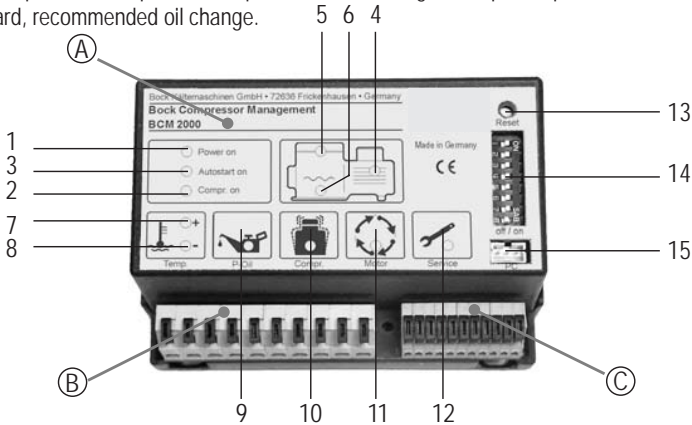

Item No.	Designation		Function
1	Mains voltage	LED green	for mains voltage
2	Compressor operation	LED green	for compressor operation
3	Automatic compressor start	LED yellow	for automatic compressor release. Compressor starts after a delay via the machine control or lube oil pre-heating
4	Motor winding temperature	LED red	when temperature too high
5	Compressed gas temperature	LED red	when temperature too high
6	Oil temperature	LED red	when temperature too low Compressor is enabled for starting only when the lube oil is pre-heated to +25°C, but at the latest after 30 min.
7	Temperature display +	LED red	comb. with item 4 / 5 / 6 temperature too high (+) or too low (-)
8	Temperature display -		
9	Oil pressure	LED red	when oil pressure too low Delay: approx. 90 s
10	Liquid detection	LED red	for liquid hammers during start-up
10	Compressor rotation detection	LED red	when compressor does not start although motor supplied with power
11	Surge guard	LED yellow	for more than 12 starts per hour Compressor continues to operate, no stop
12	Recommended oil change	LED yellow	after a certain interval has been exceeded Compressor continues to operate, no stop
13	Reset button		Reset to operating function
14	Bridging switch		Activates or bridges individual functions
15	PC interface		For reading

GB

Standard settings

Monitoring	Procedure	Value
Motor temperature	Compressor switched off at motor overtemperature Reset release when cooled down after motor overtemperature	130° C 120° C
Oil temperature	Automatic release after the oil has pre-heated ¹⁾ or automatic release after maximum pre-heating time Automatic shut-down of the compressor at oil overtemperature Automatic release when cooled down after oil overtemperature Automatic shut-down of the compressor at oil undertemperature	25° C ¹⁾ 30 min 120° C 95° C 17° C
Discharge gas temperature	Shut-down of the compressor at hot gas overtemperature Reset release when cooled down after hot gas overtemperature	140° C 130° C
Oil differential pressure	Minimum value for oil differential pressure Shut-down of the compressor when differential pressure too low ²⁾ Shut-down delay time when differential pressure too low	0,65 bar 0,6 bar ²⁾ 90s

Adjustable settings

All the errors saved in BCM 2000 (up to 170) incl. the operating hours counter total can be read out with a PC, the reading program on CD-ROM and the cable. In addition, the following trigger settings can be changed on the spot depending on the prevailing conditions:

Out-of-step:

Compressor blocked after every standart shut-down: 180 s
Variable time range: 0 - 255 s
For rack operation, set this position to "0" or hide with bypass switch 7, see pos. 7 in the chapter "error messages – information messages – emergency operation.

Oil pressure error time:

Shut-down delay (standart setting): 90 s
Variable time range: 15 - 90 s

Rotation detection:

Vibration factor (standart setting): 2
Variable time range: 0 - 40

Sensor details

Discharge gas temperature sensor:

- PTC sensor switching at 140 °C.
- Resistance range 20 - 100 Ω at 15 - 50°C (value for each sensor).
- Functioning principle: only slight change in resistance when heated up below the switching point temperature, but in the switching point range the resistance value suddenly changes by several kOhm.

Oil temperature sensor:

- Sensor KTY84-130 (see diagram: resistance temperature curve)
- Functioning principle: resistance value changes according to the change in oil temperature

Differential pressure switch: ● P Reed contact, IP 65

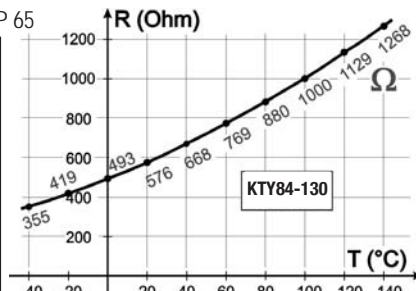
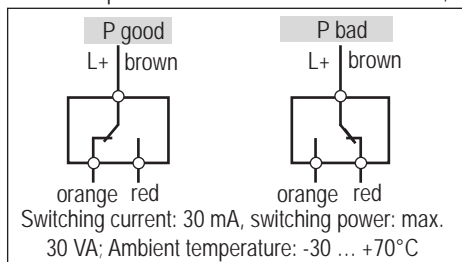

Electrical connection

Electrical connection

General

The unit has two different connection blocks:

- 1) Power supply section (B)
- 2) Control section (C)

The power supply section is for connection to the machine mains voltage. It is to be integrated in the machine control by the refrigerating engineer (qualified engineer). The unit is to be integrated in first position of the safety chain. The power supply at L1-N should be identical with the switching voltage at relay contacts 11, 12 and 14.

The control section is used for connection of the individual monitoring functions. These are normally ready wired in the factory and prefabricated ready for operation so that no additional work is necessary here.

 The whole control section (terminals 15 - 25) and all monitoring sensors, probes and corresponding connections must not have any contact with mains voltage. Otherwise the BCM 2000 and sensor components will be destroyed.

Connecting the unit

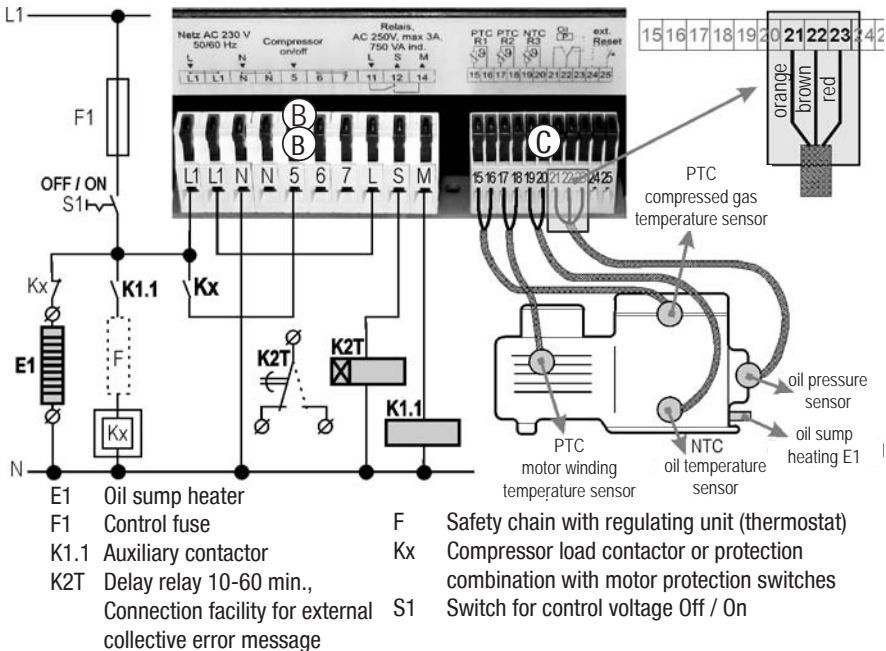

- **Electrical connection of the unit is to be carried out by a qualified electrician according to the circuit diagram.**
- **Comply with the local safety regulations.**
- **Always disconnect the machine from the power supply before and during working on the machine.**
- **Compare the voltage and frequency details on the nameplate with the details for the electricity mains. Unit may only be connected up when these coincide.**

Electrical connection

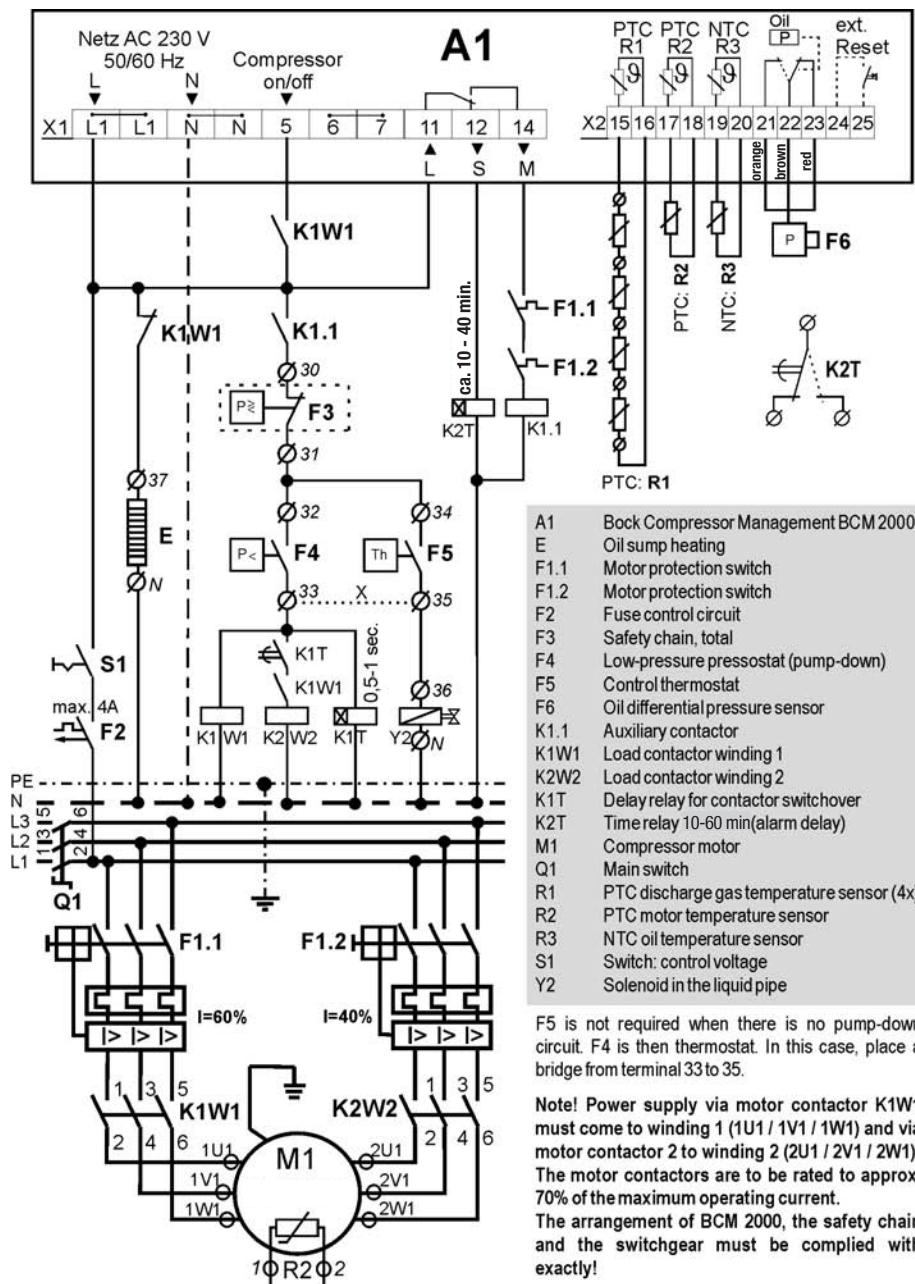

GB

Checking functions

Integration of additional switching and control components

- **Auxiliary contactor K1.1**

An auxiliary contactor K1.1 is provided to protect the contacts in the unit (max. tol. load AC 250 V / 3 A / 750 VA ind.)

- **Delay relay K2T**

A delay relay K2T 10 - 60 min is to be superposed so that various operating interruptions are not indicated as fault (adjustment range approx. 10 to 60 minutes, settling time 40 min.)

- **Oil sump heating E1**

The compressor oil sump heater E1 is to be connected up in combination with the oil temperature function. The oil sump heater should already be running during the evacuation phase.

If the oil temperature is under +25°C, the compressor is blocked and the oil sump heater is running.

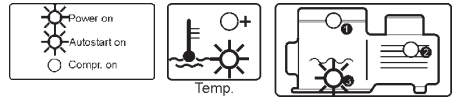

For oil temperatures exceeding +25°C, but at the latest after 30 min. pre-heating time the compressor is released for operation and the oil sump heater switches off.

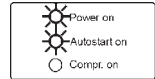

Checking the functions

General

The unit is mounted in the compressor terminal box. All monitoring sensors are connected and their functions have been checked. A separate function check is not necessary. The following function checks can be carried out when spare parts have been supplied or as part of troubleshooting:

- **Function check for compressed gas/winding/oil temperature**
- **Function check for oil pressure**

Procedure for checking the compressed gas / winding / oil temperature functions

1 Disconnect from the mains

Disconnect the temperature sensor (terminal 15, 17 or 19)
Important! Every sensor must be checked individually!

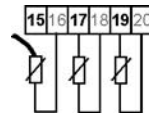

2 Insert wire bridge L1 - 5

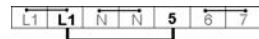

3 Apply mains voltage

The 2 corresponding LEDs must light up after 30 s delay

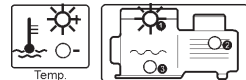

4 Disconnect from the mains, remove the wire bridge (see no. 2), connect sensor (see no. 1)

5 Apply mains voltage

Unit ready

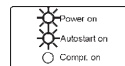

Activation / bridging the monitoring functions

Procedure for checking the oil pressure function

1 Disconnect from the mains

Disconnect the sensor (terminal 22)

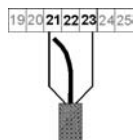

2 Insert wire bridge L1 - 5

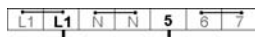

3 Apply mains voltage

The corresponding LED must light up after approx. 90 s delay



4 Disconnect from the mains, remove the wire bridge (see no. 2), connect sensor (see no. 1)

5 Apply mains voltage

Unit ready

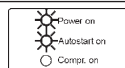

Activating or bridging individual monitoring functions

General

Each of the 8 possible functions can be individually activated or bridged. The works setting is always „activated“. Every function is numbered and allocated to the function switch with the same number. The adjustment of the function switch is only activated after quitting with the reset button for safety reasons. The adjustment can be made when the compressor is running or at a standstill.

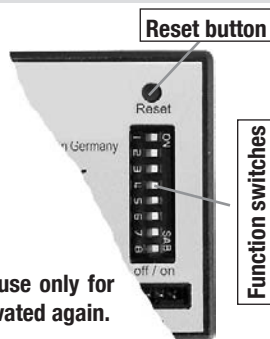

No safety functions work in bridged state. Therefore use only for emergency operation. LED flashes until function is activated again.

Bridge function

(e.g. service display)

Switch setting to the left (off)



Compressor starts up or continues through the machine control

Activate function

(e.g. service display)

Switch setting to the right (on)

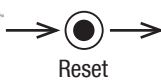

Compressor starts up or continues through the machine control; **exception:** longer power failure; operation only released after lube oil has pre-heated

Reset, messages, emergency operation

Reset

General

Every message can be quit with reset. The procedure can be repeated as often as necessary.



Caution! First rectify the fault, then release the compressor. After quitting the fault with the reset button, the compressor starts up again without any delay



Quit fault (e.g. oil fault)

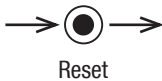

Compressor starts up immediately. **Exception:** longer power failure. operation only released after lube oil has pre-heated

Fault messages - information messages - emergency operation

General

The unit has 8 monitoring functions. These are divided into:

- 5 fault messages (compressor shutdown when triggered)
- 2 information messages (compressor not shutdown when triggered)
- 1 status message (compressor automatically released when triggered)

There are two possibilities for reactivating the messages:

- a) reset to initial function (using reset button)
- b) bridging the functions (emergency operation using function switch)

The unit can save several approx. 170 fault messages.

The device can save up to 170 error messages. The saved error messages can be read via the PC interface with the special interface cable (accessory, article no. 06988) and the Bock reading program (accessory, article no. 06992).



CAUTION! Remedy fault first, then release compressor!

No protection functions available in bridged status. Therefore only use for emergency operation! LED flashes until function activated again.





Function switches

Reset button



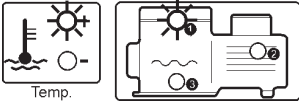

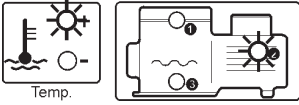

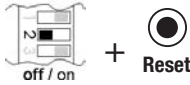
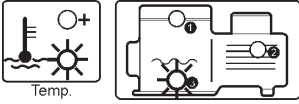
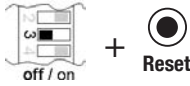
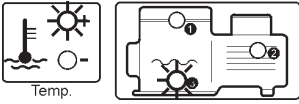
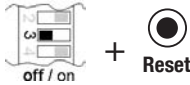





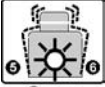

GB

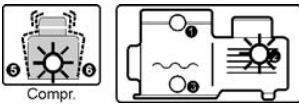
Messages and emergency operation

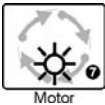
Display	a) Reset to initial function	b) Function bridged (emergency operation - no safety function)
<p>Fault message</p>  <p>1 Compressed gas temperature too high. LED ON / Compressor OFF</p>	<p>Possible after cooling down to operating temperature</p>  <p>Reset</p> <p>Compressor starts up immediately. LED OFF</p>	<p>Possible without cooling down to operating temperature</p>  <p>Switch 1 Off</p> <p>Compressor starts up through machine control. LED flashes</p>
<p>Fault message</p>  <p>2 Winding temperature too high. LED ON / Compressor OFF</p>	<p>Possible after cooling down to operating temperature</p>  <p>Reset</p> <p>Compressor starts up immediately. LED OFF</p>	<p>Possible without cooling down to operating temperature</p>  <p>Switch 2 Off</p> <p>Compressor starts up through machine control. LED flashes</p>
<p>Status message</p>  <p>3 Oil temperature too low. LED ON / Compressor OFF</p>	<p>Reset not possible Compressor starts automatically after preheating the lube oil to +25°C, but at the latest after 30 min. pre-heating time</p> <p>LED - OFF / Compressor - ON</p>	 <p>Switch 3 Off</p> <p>Compressor starts up through machine control. LED flashes</p>
<p>Status message</p>  <p>3 Oil temperature too high. LED ON / Compressor OFF</p>	<p>Reset not possible Compressor starts automatically after cooling down.</p> <p>LED - OFF / Compressor - ON</p>	 <p>Switch 3 Off</p> <p>Compressor starts up through machine control. LED flashes</p>

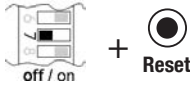
GB

Messages and emergency operation

Display	a) Reset to initial function	b) Function bridged (emergency operation - no safety function)
<p>Fault message</p>  <p>P-Oil</p> <p>4 Oil pressure too low LED ON / Compressor OFF</p>	 <p>Reset</p> <p>Compressor starts up immediately. LED OFF</p>	 <p>Switch 4 Off</p> <p>Compressor starts up through machine control. LED flashes</p>
<p>Fault message</p>  <p>Compr.</p> <p>5 Combined function 1: Liquid at start LED ON / Compressor OFF</p>	 <p>Reset</p> <p>Compressor starts up immediately. LED OFF</p>	 <p>Switch 5 Off</p> <p>5 + 6 are bridged. Compressor starts up through machine control. LED flashes</p>
<p>Fault message</p>  <p>Compr.</p> <p>6 Combined function 2: Compressor not turning. LED ON / Compressor OFF</p>	 <p>Reset</p> <p>Compressor starts up after fault eliminated. LED OFF</p>	 <p>Switch 6 Off</p> <p>Only 6 is bridged. Compressor starts up through machine control. LED OFF</p> <p>i Engine monitoring by winding temperature feeler</p>
<p>Information message</p>  <p>Motor</p> <p>7 Surge op. too high LED ON / Compressor ON</p>	<p>12 starts per hour exceeded</p>  <p>Reset</p> <p>LED OFF Reset to „0“ Counting starts again</p>	 <p>Switch 7 Off</p> <p>Compressor starts up through machine control. LED flashes</p>
<p>Information message</p>  <p>8 Recommended oil change LED ON / Compressor ON</p>	 <p>Reset</p> <p>LED OFF Reset to „0“ Evaluation starts again</p>	 <p>Switch 8 Off</p> <p>Compressor starts up through machine control. LED flashes</p>

GB

Spare parts and accessories

Spare parts and accessories

General

The basic BCM 2000 unit is designed and programmed in the factory to work with the corresponding compressor. This guarantees the best possible functional reliability. When spare parts are required, we must know the compressor type and machine number before delivering an individual unit to ensure that it will function properly.

Overview of spare parts / accessories

Item.	Designation	Art. No.
1	Electronic compressor protection Bock - BCM 2000, 230 V~ consisting of: basic unit with microprocessor for all possible functions, display with individual function displays, adjusting switches for the various functions, reset button, interface for PC connection, power supply section, control section for the individual functions	06950
2	Oil pressure monitoring ΔP 2 a: Delta-P screw-on part $\frac{3}{4}$ " 16 UNF (to version ID 17) 2 b: INT 250 - circuit part with lead 2 c: Delta-P screw-on part M20x1,5 (starting from version ID 18)	06990 06989 50225
3	Oil temperature monitoring NTC screw-on temperature sensor Thread NPTF 1/8" with lead Lead colour: <u>black</u>	06947
4	Compressed gas temperature monitoring PTC screw-on temperature sensor Thread NPTF 1/8" with lead Lead colour: <u>red-brown</u>	06033
5	Interface lead for PC connection	06988
6	CD with read-out program	06992

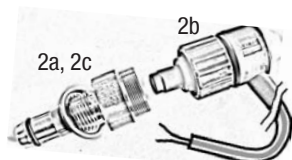
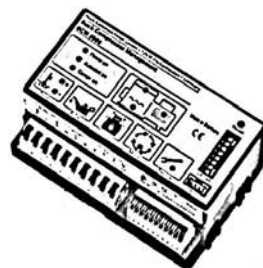

Troubleshooting

What to do, when ... ?

Display

Possible fault causes or information message

- Power on
- Autostart on
- Compr. on

- > Check control fuse and voltage at terminals L and N on the BCM 2000

Control voltage is ON
but no LED lights up

- Power on
- Autostart on
- Compr. on

- > Interruption (open contact) in the safety chain.
Check all integrated switches and units for continuity

LED „power on“ and „compressor on“
light up but the compressor does not turn

Fault message

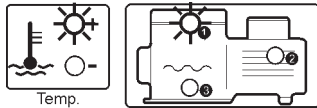

Temp.

- > discharge end temperature too high
- > Suction gas overheating too high
- > Condensing temperature too high
- > Bypass from pressure to suction side

1 = compressed gas temp. too high
LED ON / Compressor OFF

Fault message

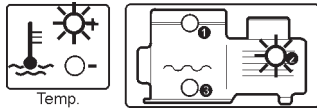

Temp.

- > Motor overload
- > Undervoltage
- > Control error
- > Winding short, short circuit, accidental ground
- > Two-phase mode
- > Motor cooling insufficient
- > Extremely unequal phase load

2 = winding temperature too high
LED ON / Compressor OFF

Status message

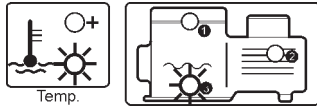

Temp.

- > Oil sump heating not working
- > Pre-heating phase too short
Operation released at +25°C, but at the latest
after 30 min. pre-heating time

3 = Oil temperature too low
LED ON / Compressor OFF

message





P-Oil

- > Oil sensor is not screwed as far as it will go into the Fault screw-in sleeve
- > Not enough oil
- > Liquid coolant in compressor / in oil
- > Dirt in machine / in oil
- > Oil pump defect
- > Inadequate oil return
- > Unsuitable oil grade
- > Damage to bearings or power plant, wear

4 = Oil pressure too low
LED ON / Compressor OFF

GB

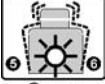
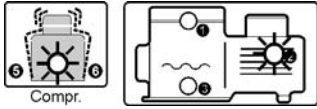
Troubleshooting

Display	Possible fault causes or information message
<p>Fault message</p>  <p>Compr.</p> <p>5 = liquid at start</p>	<ul style="list-style-type: none"> > Refrigerant or oil displaced in the machine > Check electric valve, solenoid in liquid pipe for function and leaks
<p>Fault message</p>  <p>Compr.</p> <p>6 = compressor not turning LED ON / Compressor OFF</p>	<ul style="list-style-type: none"> > One or all power supply phases not connected. > For parallel operation: Sensor possibly affected by the operation of an adjacent compressor (-> bypass function). <p>Fault message 6 is displayed although the compressor is running:</p> <ul style="list-style-type: none"> > Operating vibrations too low. Vibration sensor cannot detect the compressor running due to the exceptionally quiet operation. > Adjust the sensor's sensitivity (Bock service software required for this). This position can also be temporarily shut down without the service software by tripping DIP switch 6. Multiple monitoring of this position ensures that the compressor is fully monitored.
<p>Information message</p>  <p>Motor</p> <p>7 = Surge op. too high LED ON / Compressor ON</p>	<ul style="list-style-type: none"> > More than 12 start-ups per hour > Faulty control or setting > Insufficient refrigerant > Condenser pressure control fault > Evaporator icing > E-valve problem > SL filter or dryer contaminated
<p>Information message</p>  <p>8 = Recommended oil change LED ON / Compressor ON</p>	<ul style="list-style-type: none"> > Oil change is recommended > Filter or dryer change can be associated with this message

GB

Fault memory:

The Bock BCM 2000 (v1.4) software provides the possibility of exporting the complete fault memory of the BCM 2000 to a text file thus making a backup of it.

Procedure for backing up the fault memory:

1. A voltage of 230 V must be applied between L1 and N of the BCM 2000.
2. The BCM 2000 must be connected to a PC using the special cable.
3. Start the BCM 2000 software and wait until the fault report is read out.
4. On the "Diagnostics" screen, there is the "Export" button next to the "Retrieve" button which makes a new readout of the BCM 2000 possible when clicked.
5. The BCM 2000 software creates a text file ("Export File") when the "Export" button is clicked.
6. Select the destination where the text file should be saved. Input filename and confirm with "Save". The name of the backup file should contain the machine number, type and date.

Example: AN022334A014-HGX8-2830-4S-01012006.txt

Relevant standards

Standard	Paragraph	Designation	Value
EN 60730	2.2.15	Purpose of control unit:	Motor protection device
	6.2.6	Type of controlled load:	pilot load
	6.4	Reset characteristic:	not automatic: type 3BH automatic: type 3C
		Software class	A
		Device protection class	<input type="checkbox"/>

GB



Excellence

Passion

Integrity

Responsibility

GEA-versity

GEA Group is a global engineering company with multi-billion euro sales and operations in more than 50 countries. Founded in 1881, the company is one of the largest providers of innovative equipment and process technology. GEA Group is listed in the STOXX Europe 600 Index.



GEA Refrigeration Technologies

GEA Bock GmbH

Benzstraße 7, 72636 Frickenhausen, Germany
Telephone: +49 7022 9454-0, Fax: +49 7022 9454-137
bock@gea.com, www.bock.de