

SC15G Universal Compressor R134a 220-240V 50/60Hz

General

Code number	104G8520
Approvals	EN 60335-2-34
Compressors on pallet	80

Application

Application	LBP/HBP			
Frequency	Hz	50		60
Evaporating temperature	°C	-25 to 15		-25 to 15
Voltage range	V	187 - 254		198 - 254
Max. condensing temperature continuous (short)	°C	60 (70)		60 (70)
Max. winding temperature continuous (short)	°C	125 (135)		125 (135)

Cooling requirements

Frequency	Hz	50			60		
Application		LBP	MBP	HBP	LBP	MBP	HBP
32°C		F ₁	F ₂	F ₂	F ₁	-	-
38°C		F ₁	F ₂	F ₂	F ₁	-	-
43°C		F ₁	F ₂	F ₂	F ₁	-	-

Remarks on application: HBP at 198 - 254V 50Hz only.

Motor

Motor type	CSIR		
LRA (rated after 4 sec. UL984), HST LST	A	14.8	-
Cut in Current, HST LST	A	14.8	-
Resistance, main start winding (25°C)	Ω	5.0	13.7

Design

Displacement	cm ³	15.28
Oil quantity (type)	cm ³	550 (polyolester)
Maximum refrigerant charge	g	1300
Free gas volume in compressor	cm ³	1410
Weight without electrical equipment	kg	13.1

Dimensions

Height	mm	A	209
		B	203
		B1	183
		B2	100
Suction connector	location/I.D. mm angle	C	10.2 37°
	material comment	Cu-plated steel Al cap	
Process connector	location/I.D. mm angle	D	6.2 37°
	material comment	Cu-plated steel Al cap	
Discharge connector	location/I.D. mm angle	E	6.2 37°
	material comment	Cu-plated steel Al cap	
Oil cooler connector	location/I.D. mm angle	F	-
	material comment	-	
Connector tolerance	I.D. mm		±0.09
Remarks:			

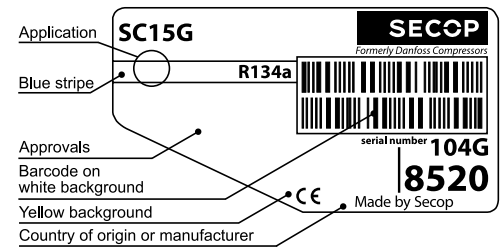

- S = Static cooling normally sufficient
- O = Oil cooling
- F₁ = Fan cooling 1.5 m/s (compressor compartment temperature equal to ambient temperature)
- F₂ = Fan cooling 3.0 m/s necessary
- SG = Suction gas cooling normally sufficient
- = not applicable in this area

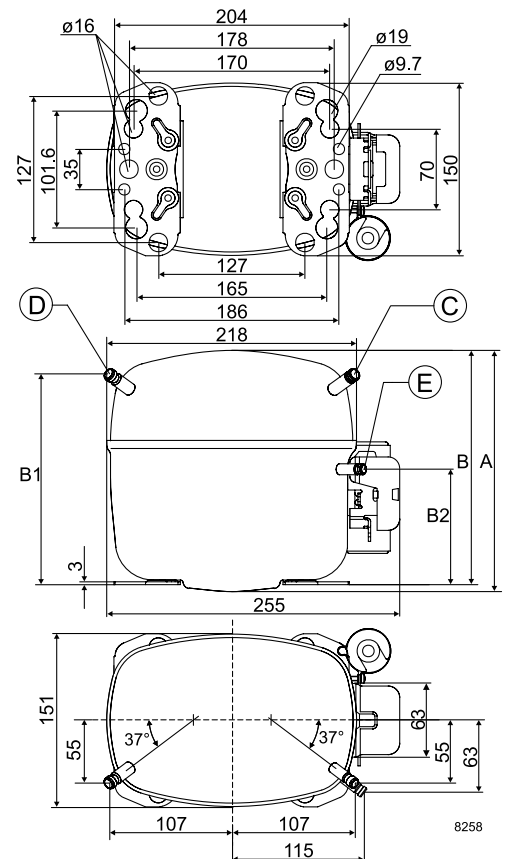

EN 12900 Household (CECOMAF) 220V, 50Hz, fan cooling F₂

Evap. temp. in °C	-45	-40	-35	-30	-25	-23.3	-20	-15	-10	-6.7	-5	0	5	7.2	10	15	20
Capacity in W					164	206	290	424	568	672	728	908	1110	1207	1340	1600	
Power cons. in W					233	259	307	376	440	478	497	549	595	613	634	667	
Current cons. in A					2.21	2.28	2.40	2.59	2.78	2.92	2.99	3.20	3.42	3.52	3.64	3.88	
COP in W/W					0.71	0.80	0.95	1.13	1.29	1.40	1.46	1.65	1.87	1.97	2.11	2.40	

ASHRAE LBP 220V, 50Hz, fan cooling F₂

Evap. temp. in °C	-45	-40	-35	-30	-25	-23.3	-20	-15	-10	-6.7	-5	0	5	7.2	10	15	20
Capacity in W					203	255	358	523	703	831	901	1124	1377	1499	1665	1993	
Power cons. in W					233	259	307	376	440	478	497	549	595	613	634	667	
Current cons. in A					2.21	2.28	2.40	2.59	2.78	2.92	2.99	3.20	3.42	3.52	3.64	3.88	
COP in W/W					0.87	0.99	1.17	1.39	1.60	1.74	1.81	2.05	2.31	2.44	2.62	2.99	

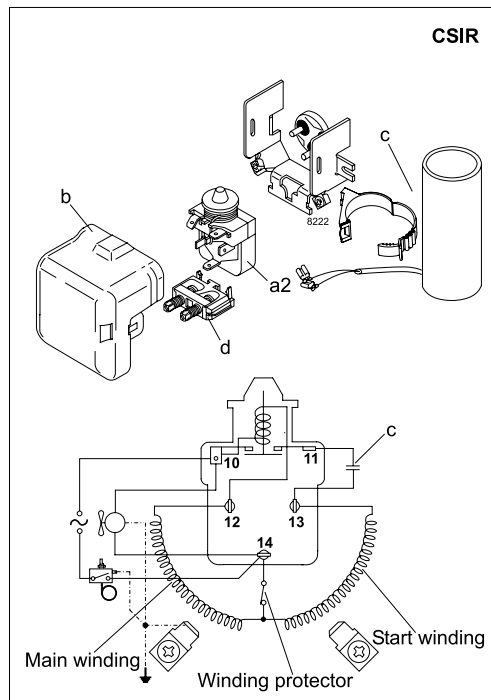

Accessories for	SC15G	Figure	Code number	Test conditions	EN 12900/CECOMAF	ASHRAE LBP
PTC starting device	6.3 mm spade connectors	a1	-	Condensing temperature	55°C	55°C
	4.8 mm spade connectors		-	Ambient temperature	32°C	32°C
Starting relay	6.3 mm spade connectors	a2	117U6005	Suction gas temperature	32°C	32°C
Cover		b	103N2009	Liquid temperature	55°C	32°C
Start. capacitor 80 µF	6.3 mm spade connectors	c	117U5017			
Cord relief		d	103N1004			
Protection screen for PTC		g	-			
				Mounting accessories	Code number	
				Bolt joint for one comp.	Ø: 16 mm	118-1917
				Bolt joint in quantities	Ø: 16 mm	118-1918
				Snap-on in quantities	Ø: 16 mm	118-1919

Danfoss can accept no responsibility for possible errors in catalogues, brochures and other printed material. Danfoss reserves the right to alter its products without notice. This also applies to products already on order provided that such alterations can be made without subsequential changes being necessary in specifications already agreed. All trademarks in this material are property of the respective companies. Danfoss and the Danfoss logotype are trademarks of Danfoss A/S. All rights reserved.